

# 0857 DEUTSCH CONNECTOR ASSEMBLY

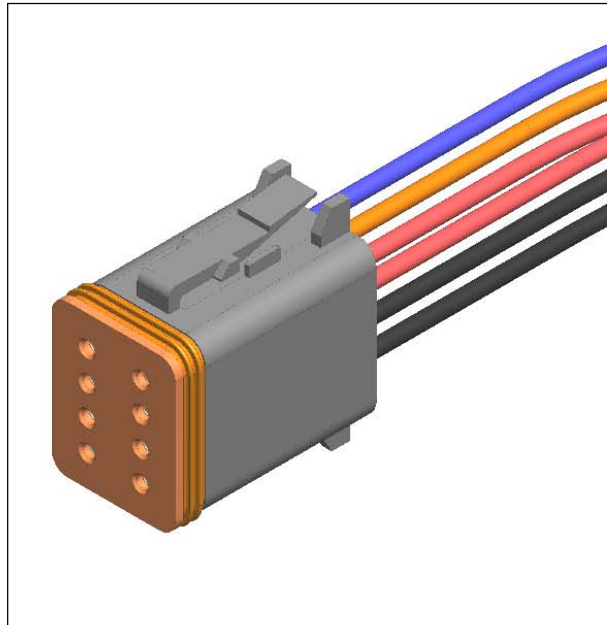

**FOR USE WITH GX AND MX SENSING CONTACTORS  
FEATURING INTEGRATED DT08 DEUTSCH CONNECTOR**

**GIGAVAC**<sup>®</sup>  
ADVANCED SWITCHING SOLUTIONS

# 0857 (ASSEMBLED)

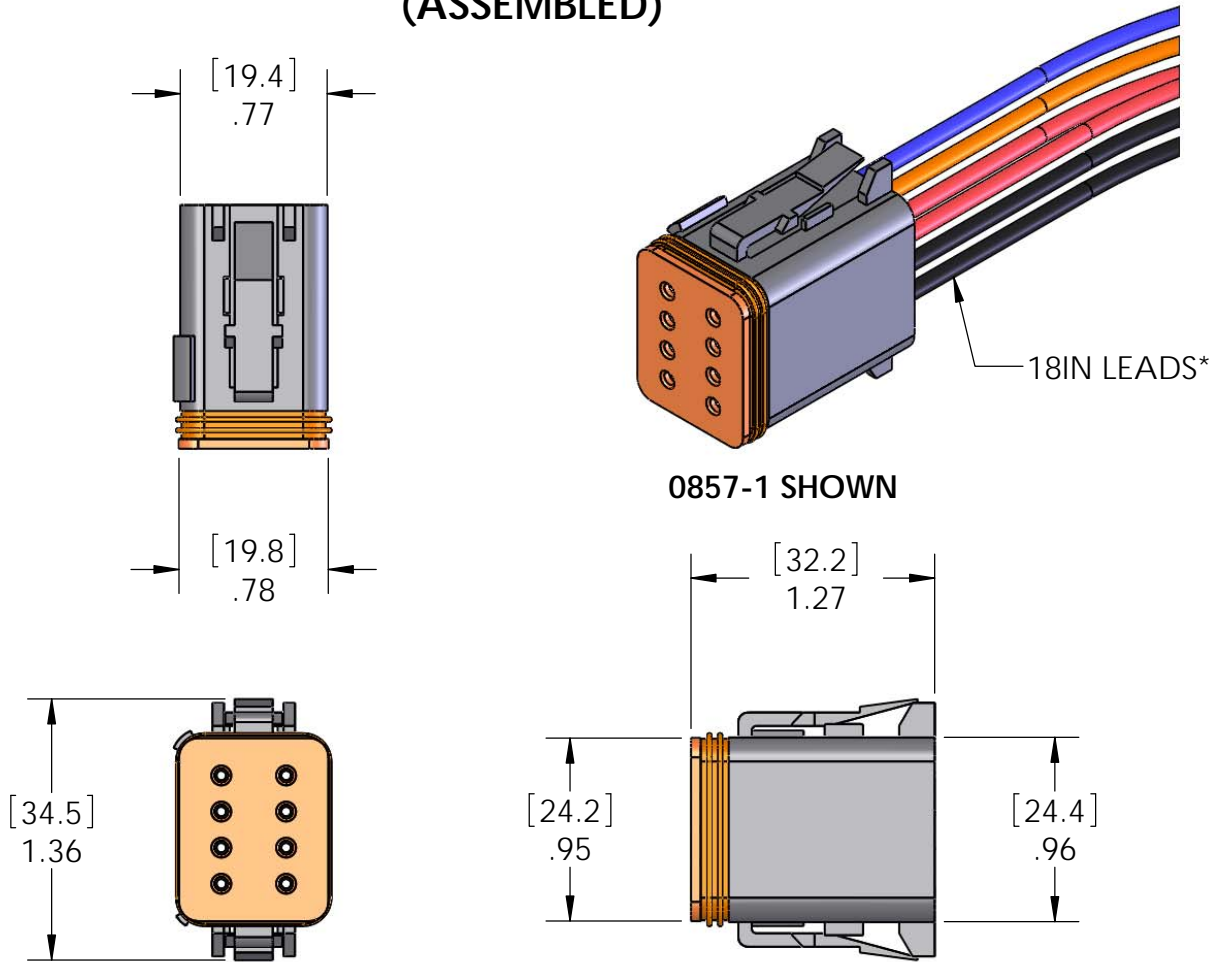

<u>PART NUMBER</u>	<u>DESCRIPTION</u>
0857-1	CURRENT SENSE
0857-2	CURRENT SENSE WITH AUXILIARY
0857-3	OVER CURRENT
0857-4	OVER CURRENT WITH AUXILIARY
0857-5	LOW VOLTAGE DISCONNECT
0857-6	LOW VOLTAGE DISCONNECT WITH AUXILIARY
0857-7	DELAY ON BREAK
0857-8	DELAY ON BREAK WITH AUXILIARY
0857-9	CAN-BUS
0857-10	CAN-BUS WITH AUXILIARY

SEE SHEET 3 FOR PINOUT CONFIGURATIONS

## MATING CONNECTOR

DEUTSCH CONNECTOR HOUSING P/N: DT06-08SA  
 SOLID CONTACT SOCKET P/N: 0462-201-16141  
 WEDGE LOCK P/N: W8S  
 SEALING PLUG P/N: 114017

## LEADS\*

UL3239 20AWG WIRE, 18 INCHES

# PINOUT CONFIGURATIONS

0857-1  
Current Sense

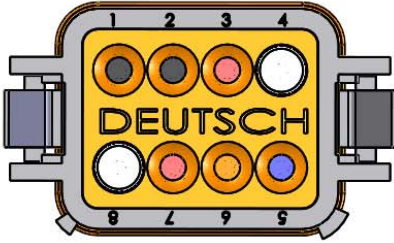

0857-2  
Current Sense with Auxiliary

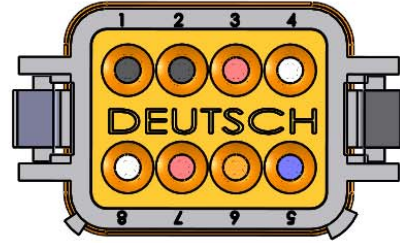

0857-3  
Over Current

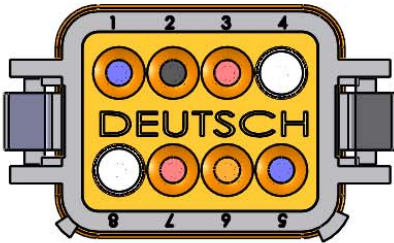

0857-4  
Over Current with Auxiliary

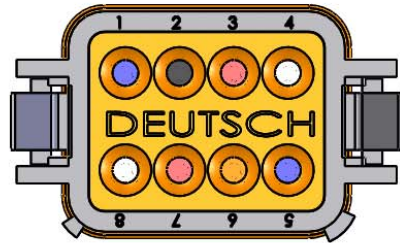

0857-5  
Low Voltage Disconnect

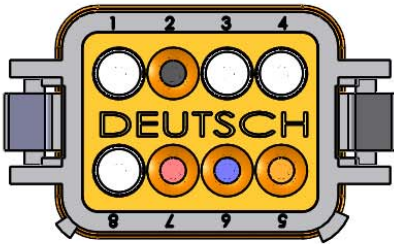

0857-6  
Low Voltage Disconnect with Auxiliary

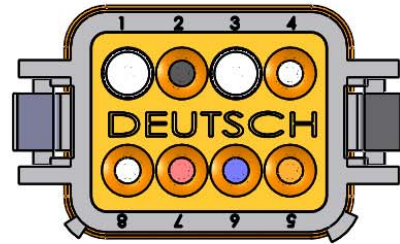

0857-7  
Delay on Break

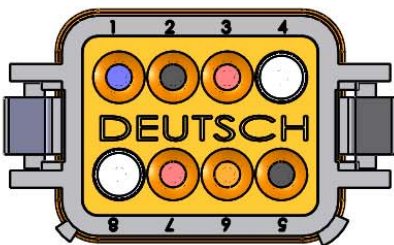

0857-8  
Delay on Break with Auxiliary

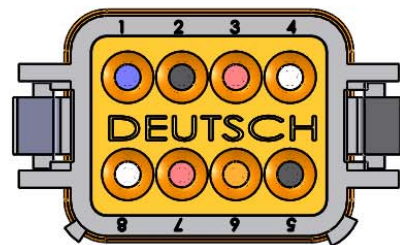

0857-9  
CAN-Bus

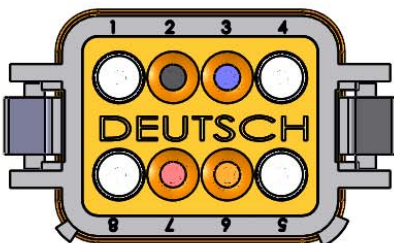

0857-10  
CAN-Bus with Auxiliary

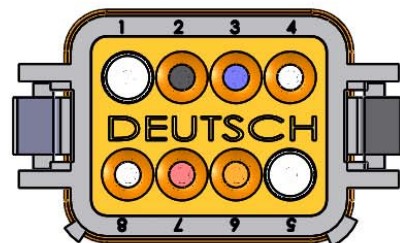

---

Datasheets provided by Sensata Technologies, Inc., its subsidiaries and/or affiliates (“Sensata”) are solely intended to assist third parties (“Buyers”) who are developing systems that incorporate Sensata products (also referred to herein as “components”). Buyer understands and agrees that Buyer remains responsible for using its independent analysis, valuation, and judgment in designing Buyer’s systems and products. Sensata datasheets have been created using standard laboratory conditions and engineering practices. Sensata has not conducted any testing other than that specifically described in the published documentation for a particular datasheet. Sensata may make corrections, enhancements, improvements, and other changes to its datasheets or components without notice.

Buyers are authorized to use Sensata datasheets with the Sensata component(s) identified in each particular datasheet. HOWEVER, NO OTHER LICENSE, EXPRESS OR IMPLIED, BY ESTOPPEL OR OTHERWISE TO ANY OTHER SENSATA INTELLECTUAL PROPERTY RIGHT, AND NO LICENSE TO ANY THIRD PARTY TECHNOLOGY OR INTELLECTUAL PROPERTY RIGHT, IS GRANTED HEREIN. SENSATA DATASHEETS ARE PROVIDED “AS IS”. SENSATA MAKES NO WARRANTIES OR REPRESENTATIONS WITH REGARD TO THE DATASHEETS OR USE OF THE DATASHEETS, EXPRESS, IMPLIED, OR STATUTORY, INCLUDING ACCURACY OR COMPLETENESS. SENSATA DISCLAIMS ANY WARRANTY OF TITLE AND ANY IMPLIED WARRANTIES OF MERCHANTABILITY, FITNESS FOR A PARTICULAR PURPOSE, QUIET ENJOYMENT, QUIET POSSESSION, AND NON-INFRINGEMENT OF ANY THIRD PARTY INTELLECTUAL PROPERTY RIGHTS WITH REGARD TO SENSATA DATASHEETS OR USE THEREOF.

All products are sold subject to Sensata’s terms and conditions of sale supplied at [www.sensata.com](http://www.sensata.com). SENSATA ASSUMES NO LIABILITY FOR APPLICATIONS ASSISTANCE OR THE DESIGN OF BUYERS’ PRODUCTS. BUYER ACKNOWLEDGES AND AGREES THAT IT IS SOLELY RESPONSIBLE FOR COMPLIANCE WITH ALL LEGAL, REGULATORY, AND SAFETY-RELATED REQUIREMENTS CONCERNING ITS PRODUCTS, AND ANY USE OF SENSATA COMPONENTS IN ITS APPLICATIONS, NOTWITHSTANDING ANY APPLICATIONS-RELATED INFORMATION OR SUPPORT THAT MAY BE PROVIDED BY SENSATA.

Mailing Address: Sensata Technologies, Inc., 529 Pleasant Street, Attleboro, MA 02703, USA

## CONTACT US

### Regional head offices:

#### United States of America

Sensata Technologies

Attleboro, MA

**Phone:** 508-236-3800

**E-mail:** [support@sensata.com](mailto:support@sensata.com)

#### Netherlands

Sensata Technologies Holland B.V.

Hengelo

**Phone:** +31 74 357 8000

**E-mail:** [support@sensata.com](mailto:support@sensata.com)

#### China

Sensata Technologies China Co., Ltd.

Shanghai

**Phone:** +8621 2306 1500

**E-mail:** [support@sensata.com](mailto:support@sensata.com)

Copyright © 2023 Sensata Technologies, Inc.