

Coil Ratings at 25°C

Coil P/N Designation	P	R
Coil Voltage, Nominal (VDC)	12/24	12/24
Coil Type	External PWM ⁴	
Coil Resistance (ohms)	1.45	5
Operate Time, Max (ms) ⁵	20	
Release Time, Max (ms)	12	



POWER SWITCHING AND CURRENT CARRY RATINGS

DC POWER SWITCHING CYCLES

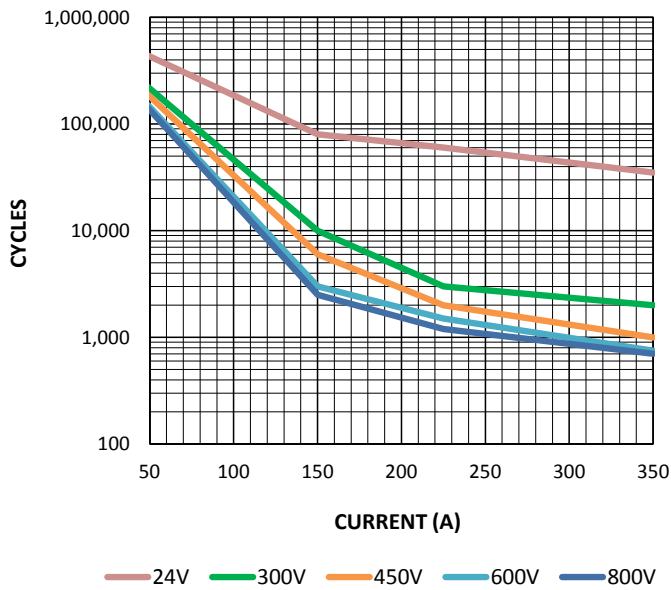

CURRENT CARRY vs TIME

with 85°C terminal temperature rise

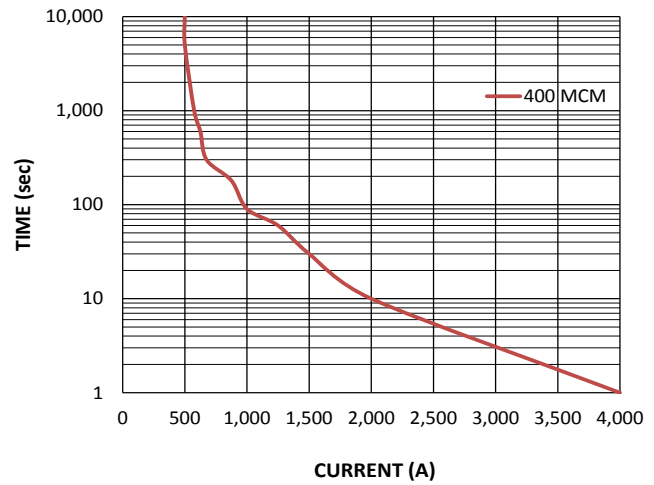



SIDE MOUNT DIMENSIONS

Side Mount

(Auxiliary with Main Terminal Connection for Sensing Voltage Across Contacts or Bolted Joint Resistance Shown)

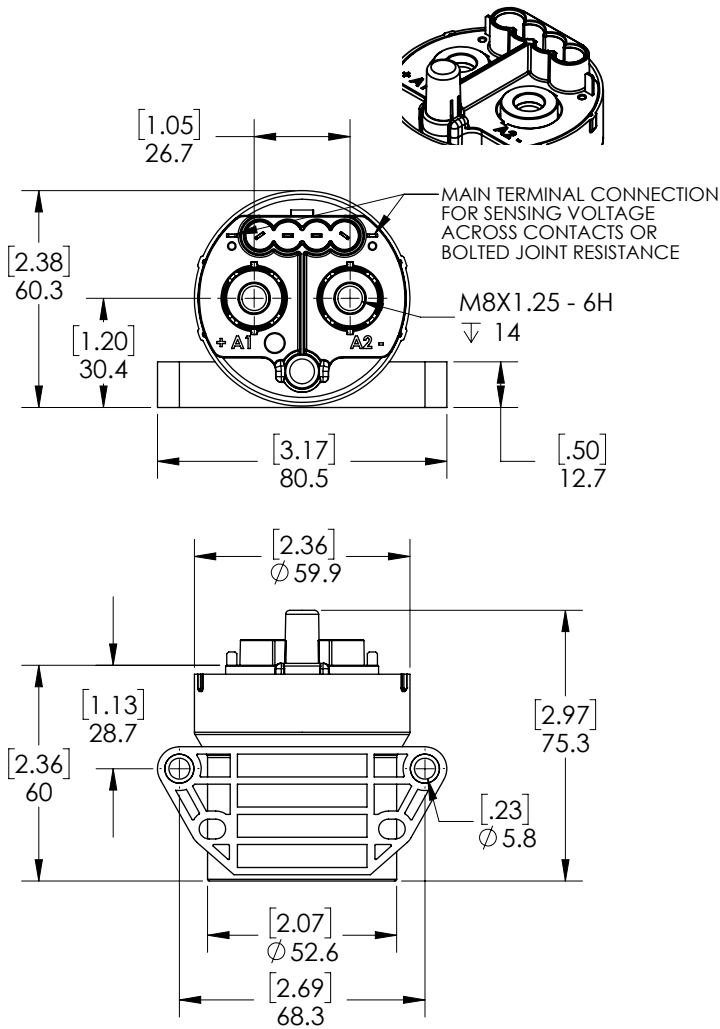

Side Mount

(Auxiliary Shown)

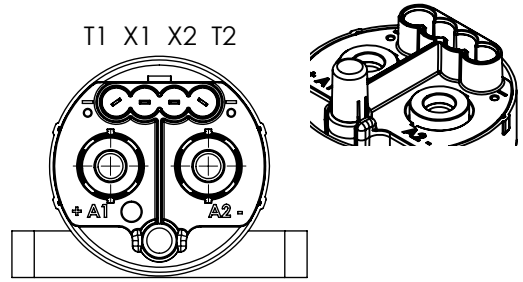

Coil/Auxiliary Connector

Coil: Tin Plated Brass
Auxiliary: Tin Plated Beryllium Copper

Mounting

M5 or No. 10 Screws
Torque 1.7-4 Nm [15-35 in-lb]

Power Connection

Silver Plated Copper M8x1.25 Terminals
Torque 10 Nm [90 in-lb] max

Auxiliary Contacts (Optional)

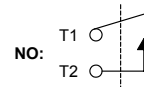

Temperature and Weight

Operating ambient Temp Range = -55 to +85°C³
Storage ambient Temp Range = -70 to +150°C
Weight, typical = 0.39 kg (0.86 lb)

Power Contacts

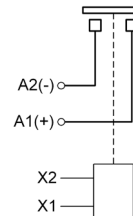

Packaging

24 units per shipping box
21 in x 18 in x 4 in shipping box



ORDERING OPTIONS

Example : GV351PPBX

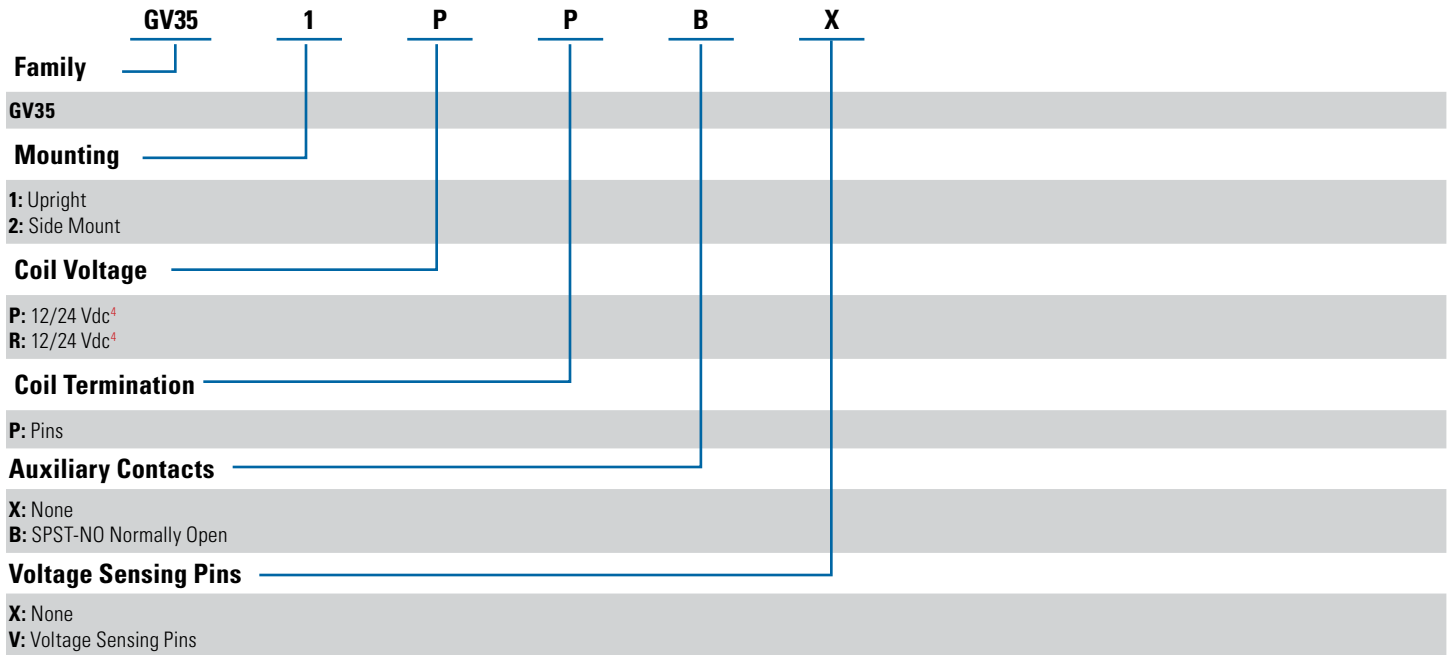

GENERAL NOTES

1. Auxiliary contact rating is 2A, 24Vdc Resistive load, 100,000 cycles. Minimum current is 0.1mA, 5V. The auxiliary contact is mechanically linked to the main power contacts.
2. Insulation resistance is 50 Mohms after life.
3. Contactor can operate up to 125°C in special cases - contact Sensata for details.
4. See Application Note [AN-022](#) for PWM instructions.
5. Operation time is measured at 25°C and includes maximum 7ms bounce.
6. Rated voltage refers to max voltage for which make/break load cycles are provided. Contactor can be used in higher voltage systems. Contact Sensata for more info.



TECHNICAL NOTES

1. Power switching lifecycles are based on **current flow** from A1(+) to A2(-). For best breaking performance, the contactor should be installed so that current flows from A1(+) to A2(-). There are cases where the contactor will interrupt power in the opposite direction but please contact Sensata to confirm suitability. Direction of current flow is not relevant during make or when flowing on closed contacts. For bi-directional contactors, please contact Sensata.
2. Applications with capacitors will require a [pre-charge](#) circuit.
3. Electrical life rating is based on resistive load with 27µH maximum inductance in circuit. Because your application may be different, we suggest you test the contactor in your circuit to verify life is as required.
4. End of life is defined as when the dielectric, insulation resistance or contact resistance exceeds the specifications listed.

Sensata Technologies, Inc. ("Sensata") data sheets are solely intended to assist designers ("Buyers") who are developing systems that incorporate Sensata products (also referred to herein as "components"). Buyer understands and agrees that Buyer remains responsible for using its independent analysis, valuation, and judgment in designing Buyer's systems and products. Sensata data sheets have been created using standard laboratory conditions and engineering practices. Sensata has not conducted any testing other than that specifically described in the published documentation for a particular data sheet. Sensata may make corrections, enhancements, improvements, and other changes to its data sheets or components without notice.

Buyers are authorized to use Sensata data sheets with the Sensata component(s) identified in each particular data sheet. HOWEVER, NO OTHER LICENSE, EXPRESS OR IMPLIED, BY ESTOPPEL OTHERWISE TO ANY OTHER SENSATA INTELLECTUAL PROPERTY RIGHT, AND NO LICENSE TO ANY THIRD PARTY TECHNOLOGY OR INTELLECTUAL PROPERTY RIGHT, IS GRANTED HEREIN. SENSATA DATA SHEETS ARE PROVIDED "AS IS". SENSATA MAKES NO WARRANTIES OR REPRESENTATIONS WITH REGARD TO THE DATA SHEETS OR USE OF THE DATA SHEETS, EXPRESS, IMPLIED, OR STATUTORY, INCLUDING ACCURACY OR COMPLETENESS. SENSATA DISCLAIMS ANY WARRANTY OF TITLE AND ANY IMPLIED WARRANTIES OF MERCHANTABILITY, FITNESS FOR A PARTICULAR PURPOSE, QUIET ENJOYMENT, QUIET POSSESSION, AND NON-INFRINGEMENT OF ANY THIRD PARTY INTELLECTUAL PROPERTY RIGHTS WITH REGARD TO SENSATA DATA SHEETS OR USE THEREOF.

All products are sold subject to Sensata's terms and conditions of sale supplied at www.sensata.com SENSATA ASSUMES NO LIABILITY FOR APPLICATIONS ASSISTANCE OR THE DESIGN OF BUYERS' PRODUCTS. BUYER ACKNOWLEDGES AND AGREES THAT IT IS SOLELY RESPONSIBLE FOR COMPLIANCE WITH ALL LEGAL, REGULATORY, AND SAFETY-RELATED REQUIREMENTS CONCERNING ITS PRODUCTS, AND ANY USE OF SENSATA COMPONENTS IN ITS APPLICATIONS, NOTWITHSTANDING ANY APPLICATIONS-RELATED INFORMATION OR SUPPORT THAT MAY BE PROVIDED BY SENSATA.

Mailing Address: Sensata Technologies, Inc., 529 Pleasant Street, Attleboro, MA 02703, USA

Americas

Sensata GIGAVAC
 Contactor Center of Excellence
 6382 Rose Lane
 Carpinteria, CA 93013
 USA
 Tel: +1 (805) 684 8401
 Email: gigavac@sensata.com
 Sensata Global Headquarters
 Sensata Technologies
 529 Pleasant Street
 Attleboro, MA 02703
 USA

Europe, Middle East & Africa

Sensata Technologies Holland B.V.
 Jan Tinbergenstraat 80
 7559 SP Hengelo
 The Netherlands
 Tel: +31743578000
 Email: gigavac-info-eu@list.sensata.com

CONTACT US

Asia Pacific

China
 Sensata Technologies China Co., Ltd.
 BM Intercontinental Business Center
 30th Floor
 100 Yu Tong Road
 Shanghai 200070
 People's Republic of China
 Tel: +8621 2306 1500
 Email: contactorasia@list.sensata.com
 Japan
 Sensata Technologies Japan Ltd.
 Shin Yokohama Square Bldg. 7F
 2-3-12 Shin-yokohama
 Kohoku-ku, Yokohama-shi,
 Kanagawa 222-0033
 Tel: +81 45 277 7001
 Email: contactorasia@list.sensata.com