

LOAD MONITORING MODULE | DRML1

SSR ACCESSORIES

Description

The DRML1 Load Monitoring Module is designed to be plugged on top of any Nova22 Solid State Relay with Contactor configuration (PM22 and DR22 Series with options V or W) to monitor up to 8 heating elements with similar current value, with a total current ranging from 1.2 Amps up to 50 Amps.

The DRML1 module permanently measures the load current and compares it against a pre-set nominal value (TEACH value) which is stored during the installation of the module either by pressing the "Teach-In" pushbutton, placed on the front, or with the external "Teach-In" input.

The alarm output is activated when the module detects an undercurrent of 12.5% below the nominal value, which corresponds to the failure of a single load. The module can also detect other fault conditions, such as: overcurrent (current

exceeding 12.5% of the nominal current), blown fuses (open load), damaged (short circuited) or interrupted SSR, and it can also detect half-wave operation.

The maximum current value (20 Amps or 50 Amps) and an adjustable alarm response delay (0.1 sec, 1 sec or 5 secs) are selectable on the front via the parameter selector switch. The alarm delay avoids fault messages generated by voltage drops.

Malfuncions are indicated by a multicolor LED, which indicates when power is ON and also when the Teach-In function is activated (Blue), when the input signal is ON (Green) and when an alarm condition is activated (Red).

The DRML1 module is ideal for monitoring the correct operation of a wide range of equipment, such as injection molding, plastic extrusion and thermoforming machines.



Features

- Sensing current range from 1.2 to 50 Amps at 600 VAC
- Up to 8 resistive loads can be monitored
- Under & Overcurrent detection
- No Mains Voltage/ Open Load and SSR Short Circuit detection
- Compatible with DIN Rail and Panel Mount SSRs (DR2260DxxV/W & PM2260DxxV)
- Easy installation and removal
- LED status indicator
- IP20 touch-safe housing
- Up to 128 outputs can be connected in parallel

NOVA22

PRODUCT SELECTION

Module Type	
Load Monitoring	DRML1

POWER SUPPLY SPECIFICATIONS ⁽¹⁾

Description	DRML1
Supply Voltage Range	8-30 VDC
Minimum Supply Current	10 mA
Maximum Supply Current	30 mA

INPUT SPECIFICATIONS ⁽¹⁾

Description	DRML1
Input Voltage Range	4-32 VDC
Minimum Input Current	100 µA
Maximum Input Current	1.5 mA
Maximum Turn-On Time (Ton)	15 msec
Maximum Turn-Off Time (Toff)	15 msec

EXTERNAL TEACH SPECIFICATIONS ⁽¹⁾

Description	DRML1
External Teach Voltage Range	4-32 VDC
Minimum Input Current	100 μ A
Maximum Input Current	1.5 mA

CURRENT SENSING SPECIFICATIONS ⁽¹⁾

Description	DRML1
Maximum Teach Current	50 A _{RMS}
Minimum Teach Current	1.2 A _{RMS}
Teach Current	1.2-20 A _{RMS}
	3.2-50 A _{RMS}
Minimum Single Load Current	0.15 A _{RMS}
	0.40 A _{RMS}
Undercurrent Detection	Teach Current * 0.875 A _{RMS}
Overcurrent Detection	Teach Current * 1.125 A _{RMS}
Load Voltage Frequency Range	47-400 Hz
Load Voltage Range	48-600 VAC
Number of Loads	1 to 8

ALARM SPECIFICATIONS ⁽¹⁾

Description	DRML1
Output Voltage Range	6-29.8 VDC
Output Voltage @ Max. Current (24 VDC supply)	22 VDC
Maximum Output Current ⁽²⁾	100 mA
Minimum Output Current	1 mA
Maximum Off-State Leakage Current @ Rated Voltage	1 μ A
Maximum Number of Outputs Connected in Parallel ⁽³⁾	128
Alarm Delay Time	0.1 sec
	1 sec
	5 sec
No Mains Voltage/ Open Load Detection Current Min/Max	0.1 \pm 0.035 sec
	1 \pm 0.1 sec
	5 \pm 0.1 sec
	50 mA _{RMS} / 500 mA _{RMS}
	100 mA _{RMS} / 1.0 A _{RMS}

GENERAL SPECIFICATIONS ⁽¹⁾

Description	Parameters
Dielectric Strength, Input to Output (50/60Hz)	4000 V _{RMS}
Minimum Insulation Resistance (@ 500 VDC)	10 ⁹ Ohms
Maximum Capacitance, Input/Output	14 pF
Ambient Operating Temperature Range	-25 to 70 °C
Ambient Storage Temperature Range	-25 to 70 °C
Weight (typical)	1.5 oz (43 g)
Housing Material	UL94 V-0
Humidity	95% non-condensing
LED Input Status Indicator	See Status Chart

THERMAL DERATE INFORMATION

Alarm Output Current

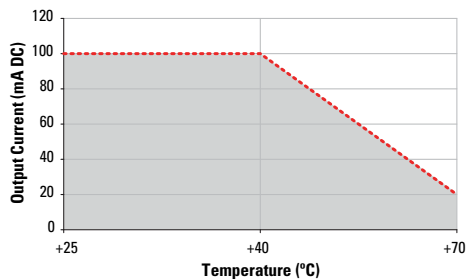



EQUIVALENT CIRCUIT BLOCK DIAGRAMS/WIRING DIAGRAM

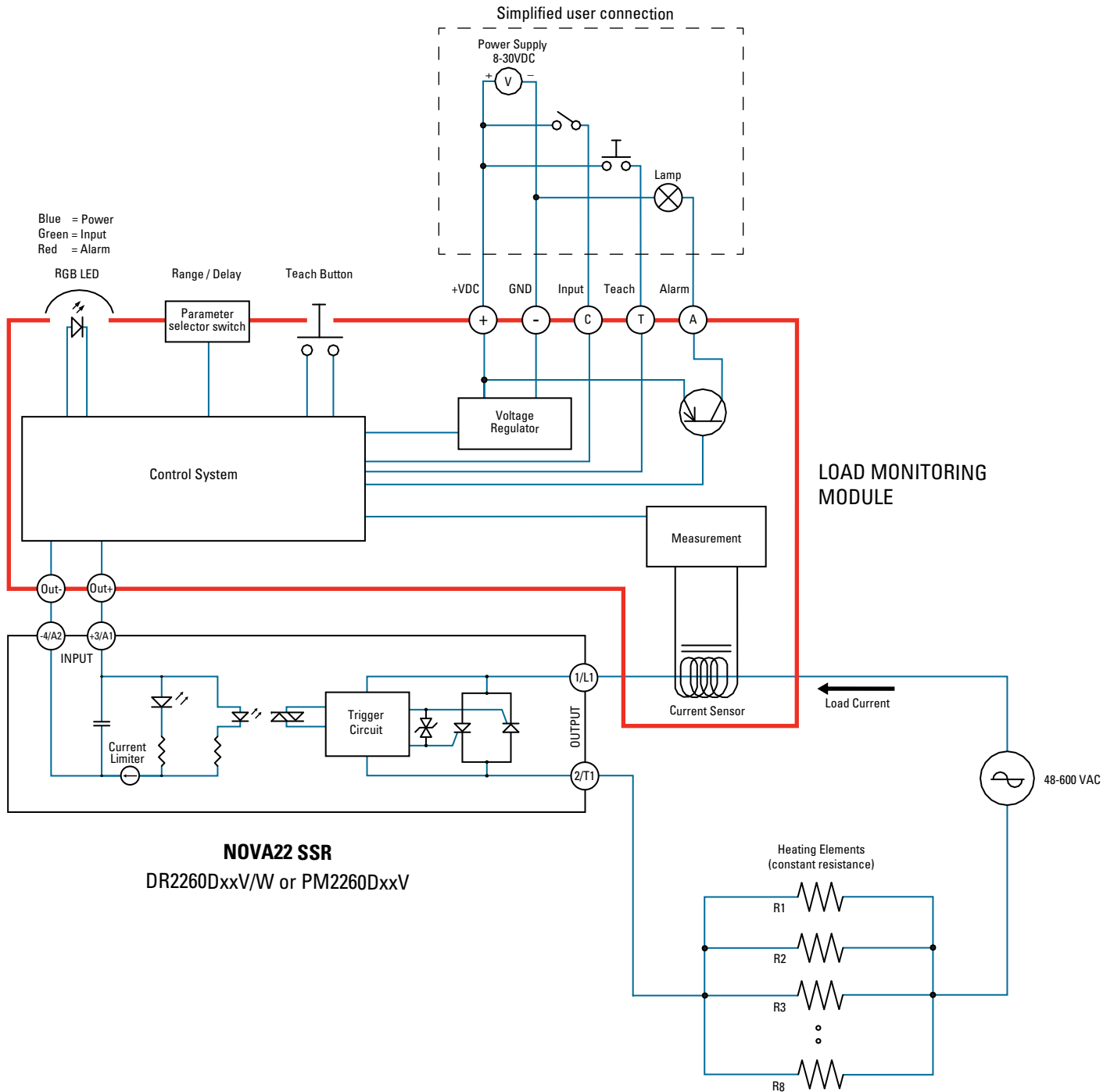



INSTALLATION INSTRUCTIONS

- Remove the ID marker and input connector from the NOVA22 relay.
- Wire input and output as shown in the Wiring Diagram. Before wiring terminal 2/T1 pass the wire through the module hole. For recommended wire sizes and terminal torques see TABLE 1.
- Mount the module onto the relay as shown in steps 1 and 2.
- Proceed to configure the module:
 - ◆ Select the maximum load current (20 Amps or 50 Amps) and the alarm delay (0.1, 1 or 5 secs) using the parameter selector switch. NOTE: Parameter selector switch is updated at startup or if no input signal is present.
 - ◆ Turn on all power supplies.
 - ◆ Press TEACH-IN button (or apply external TEACH-IN input) for 3 seconds to store the nominal load current value. LED will blink Blue 3 times when TEACH process is complete.
 - ◆ Module will start monitoring the system once TEACH-IN button has been released. Refer to TABLE 1 and Status Charts for detailed operation and status.
- For module removal follow steps 3 and 4.

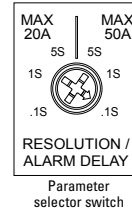

Module Mounting

STEP 1:
Align the module to the bottom of SSR

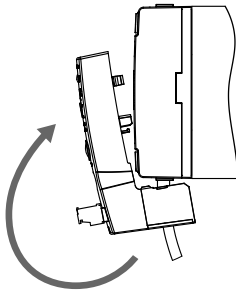

STEP 2:
Push to put into place as shown

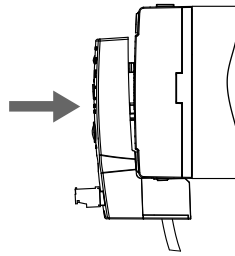

Module Removal

STEP 3:
Loosen screw of terminal 2/T1

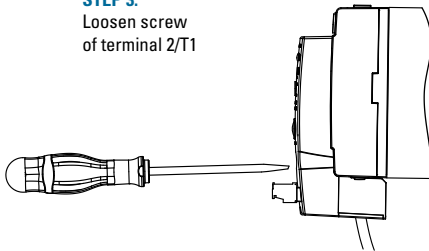

STEP 4:
Hold module and pull to remove

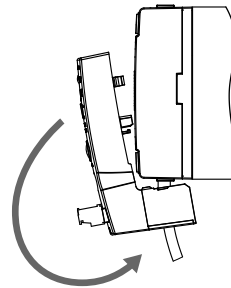

TABLE 1. Recommended Torque and Wire Sizes

Terminal	Max. Screw Torque [in-lb (Nm)]	Wire Size (Solid / Stranded)	Wire Pull-Out Strength (lb)[N]
Output	18-20 (2.0-2.2)	20 AWG (0.75 mm ²) [minimum]	25 [111]
		10 AWG (6 mm ²)	70 [310]
		8 AWG (10 mm ²) [maximum]	70 [310]
Input	1.6 (0.19)	28 AWG (0.09 mm ²) [minimum]	2.2 [9.8]
		14 AWG (2.5 mm ²) [maximum]	22 [98]

TABLE 2. LED Status

Status	LED Indicator	SSR Output	Alarm Output
No Power	Off	OFF	OFF
Power ON [brand new, no TEACH value]	Blinking Blue constantly	OFF	OFF
Power ON [TEACH value stored]	Blinking Blue 3 times	OFF	OFF
Power ON [TEACH value operative]	Blue	OFF	OFF
Input Control ON	Green	ON	OFF
ALARM - No Mains Voltage/ Open Load	Red	OFF	ON
ALARM - Undercurrent	Blinking Red 1 time	ON	ON
ALARM - Overcurrent	Blinking Red 2 times	ON	ON
ALARM - SSR Short Circuit	Blinking Red constantly	ON	ON

LED Color



Status Chart-Normal Operation

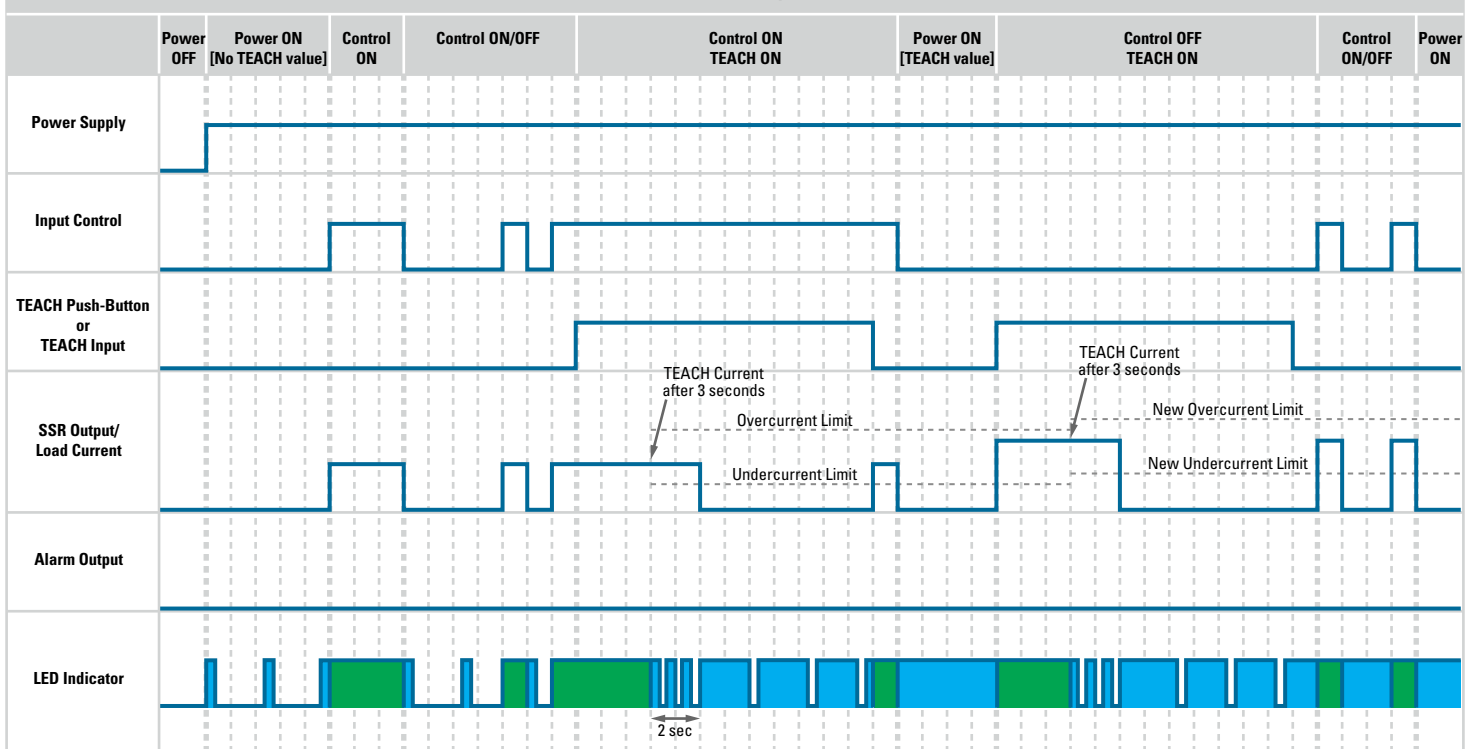

LED Color



Status Chart - Fault Operation

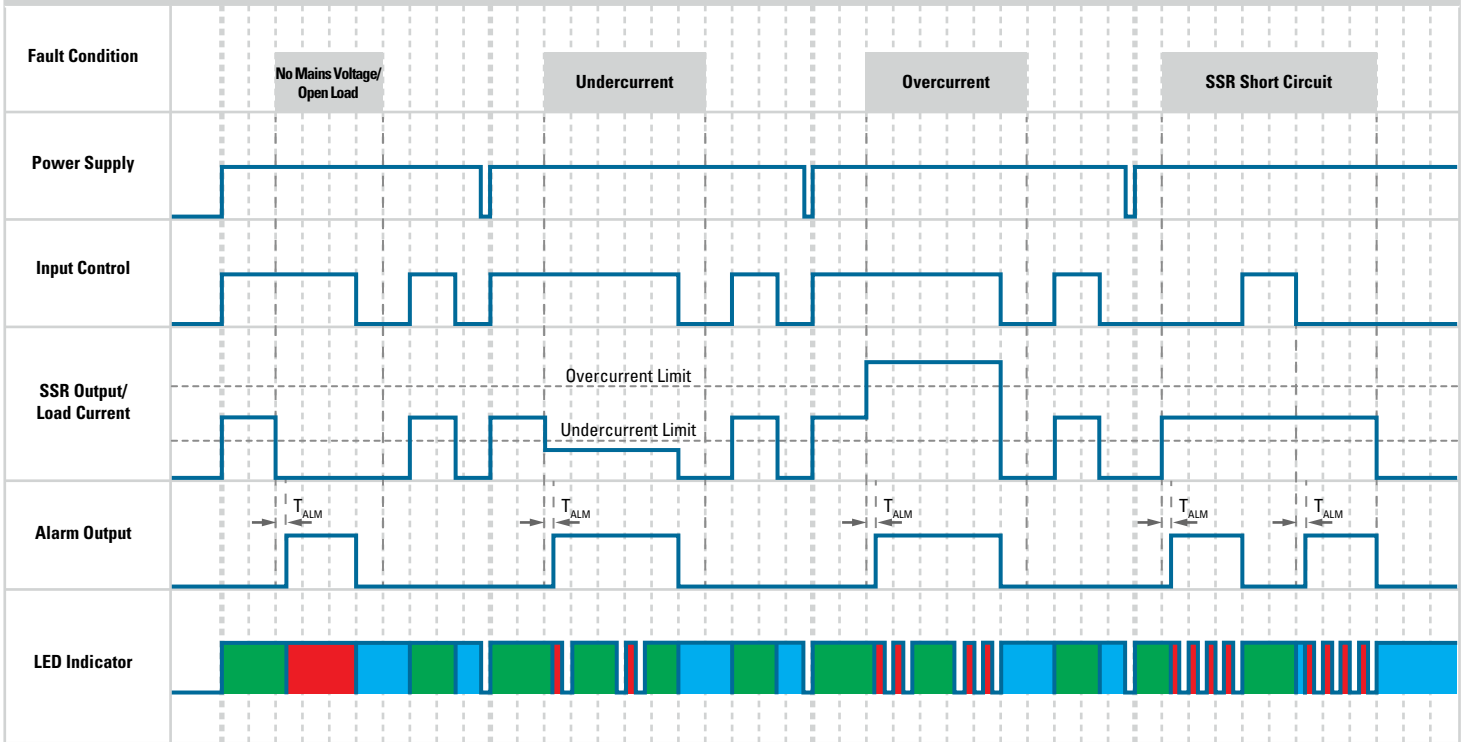

T_{ALM} = Alarm Delay Time

LED Color

- Blue
- Green
- Red

MECHANICAL SPECIFICATIONS

Tolerances: ± 0.02 in / 0.5 mm
All dimensions are in: inches [millimeters]

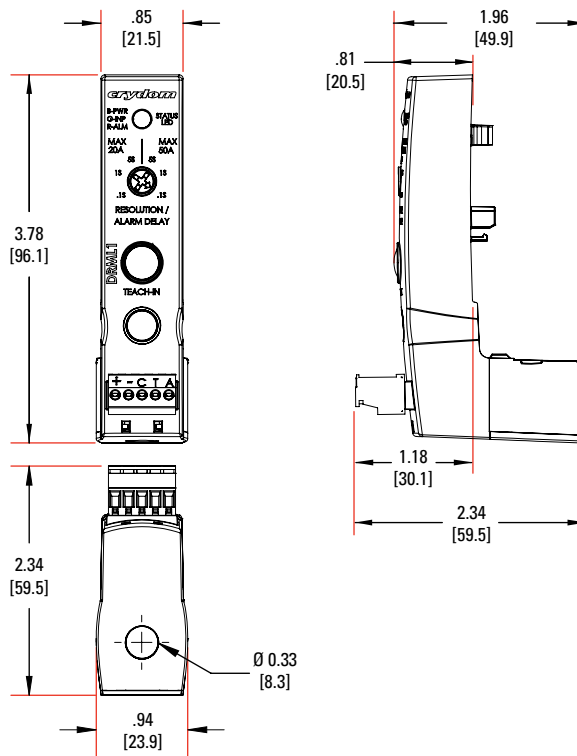

Approvals	
	   

Conformances	
United States Standard for Industrial Control Equipment - UL 508 and Canadian Standard Association for Industrial Control Equipment – C22.2 No. 14.	
Vibration Resistance	IEC 60068-2-6: Amplitude Range 10-55 Hz, Displacement 0.75 mm
Shock Resistance	IEC 60068-2-27: Peak Acceleration 15g, Duration 11ms.

Electromagnetic Compatibility				
Generic Standard	Immunity Tests	Test Specification Level	Performance	
IEC 61000-6-2 Immunity for Industrial Environments	Electrostatic Discharge IEC 61000-4-2	8kV air discharge	Criterion A	
		6kV contact discharge	Criterion A	
	Fast transients (burst) IEC 61000-4-4	Output	2kV, 5kHz, 100kHz	Criterion B
		Input	1kV, 5kHz, 100kHz	Criterion B
	Surge IEC 61000-4-5	Output	1kV Line to Line	Criterion B
			2kV Line to Earth	Criterion B
	DC Port	500 VDC Source Terminal	Criterion A	

 GENERAL NOTES

- (1) All parameters at 25°C unless otherwise specified.
- (2) For ambient temperatures above 40°C see the Alarm Output derate curve.
- (3) With a minimum alarm load current of 10mA (Impedance ≤ 2.4kΩ @ 24 VDC).

 WARNINGS



RISK OF MATERIAL DAMAGE AND HOT ENCLOSURE

- The product’s side panels may be hot, allow the product to cool before touching
- Follow proper mounting instructions including torque values
- Do not allow liquids or foreign objects to enter this product

Failure to follow these instructions can result in serious injury, or equipment damage.



HAZARD OF ELECTRIC SHOCK, EXPLOSION OR ARC FLASH

- Disconnect all power before installing or working with this equipment
- Verify all connections and replace all covers before turning on power

Failure to follow these instructions will result in death or serious injury

Sensata Technologies, Inc. (“Sensata”) data sheets are solely intended to assist designers (“Buyers”) who are developing systems that incorporate Sensata products (also referred to herein as “components”). Buyer understands and agrees that Buyer remains responsible for using its independent analysis, evaluation and judgment in designing Buyer’s systems and products. Sensata data sheets have been created using standard laboratory conditions and engineering practices. Sensata has not conducted any testing other than that specifically described in the published documentation for a particular data sheet. Sensata may make corrections, enhancements, improvements and other changes to its data sheets or components without notice.

Buyers are authorized to use Sensata data sheets with the Sensata component(s) identified in each particular data sheet. HOWEVER, NO OTHER LICENSE, EXPRESS OR IMPLIED, BY ESTOPPEL OR OTHERWISE TO ANY OTHER SENSATA INTELLECTUAL PROPERTY RIGHT, AND NO LICENSE TO ANY THIRD PARTY TECHNOLOGY OR INTELLECTUAL PROPERTY RIGHT, IS GRANTED HEREIN. SENSATA DATA SHEETS ARE PROVIDED “AS IS”. SENSATA MAKES NO WARRANTIES OR REPRESENTATIONS WITH REGARD TO THE DATA SHEETS OR USE OF THE DATA SHEETS, EXPRESS, IMPLIED OR STATUTORY, INCLUDING ACCURACY OR COMPLETENESS. SENSATA DISCLAIMS ANY WARRANTY OF TITLE AND ANY IMPLIED WARRANTIES OF MERCHANTABILITY, FITNESS FOR A PARTICULAR PURPOSE, QUIET ENJOYMENT, QUIET POSSESSION, AND NON-INFRINGEMENT OF ANY THIRD PARTY INTELLECTUAL PROPERTY RIGHTS WITH REGARD TO SENSATA DATA SHEETS OR USE THEREOF.

All products are sold subject to Sensata’s terms and conditions of sale supplied at www.sensata.com SENSATA ASSUMES NO LIABILITY FOR APPLICATIONS ASSISTANCE OR THE DESIGN OF BUYERS’ PRODUCTS. BUYER ACKNOWLEDGES AND AGREES THAT IT IS SOLELY RESPONSIBLE FOR COMPLIANCE WITH ALL LEGAL, REGULATORY AND SAFETY-RELATED REQUIREMENTS CONCERNING ITS PRODUCTS, AND ANY USE OF SENSATA COMPONENTS IN ITS APPLICATIONS, NOTWITHSTANDING ANY APPLICATIONS-RELATED INFORMATION OR SUPPORT THAT MAY BE PROVIDED BY SENSATA.

Mailing Address: Sensata Technologies, Inc., 529 Pleasant Street, Attleboro, MA 02703, USA.

CONTACT US

- Americas**
+1 (877) 502 5500 – Option 2
sales.crydom@sensata.com
- Europe, Middle East & Africa**
+44 (1202) 416170
ssr-info.eu@sensata.com
- Asia Pacific**
sales.isasia@list.sensata.com
China +86 (21) 2306 1500
Japan +81 (45) 277 7117
Korea +82 (31) 601 2004
India +91 (80) 67920890
Rest of Asia +886 (2) 27602006
ext 2808