

crydom[®]

The Global Expert in **Solid State Switching** Technology

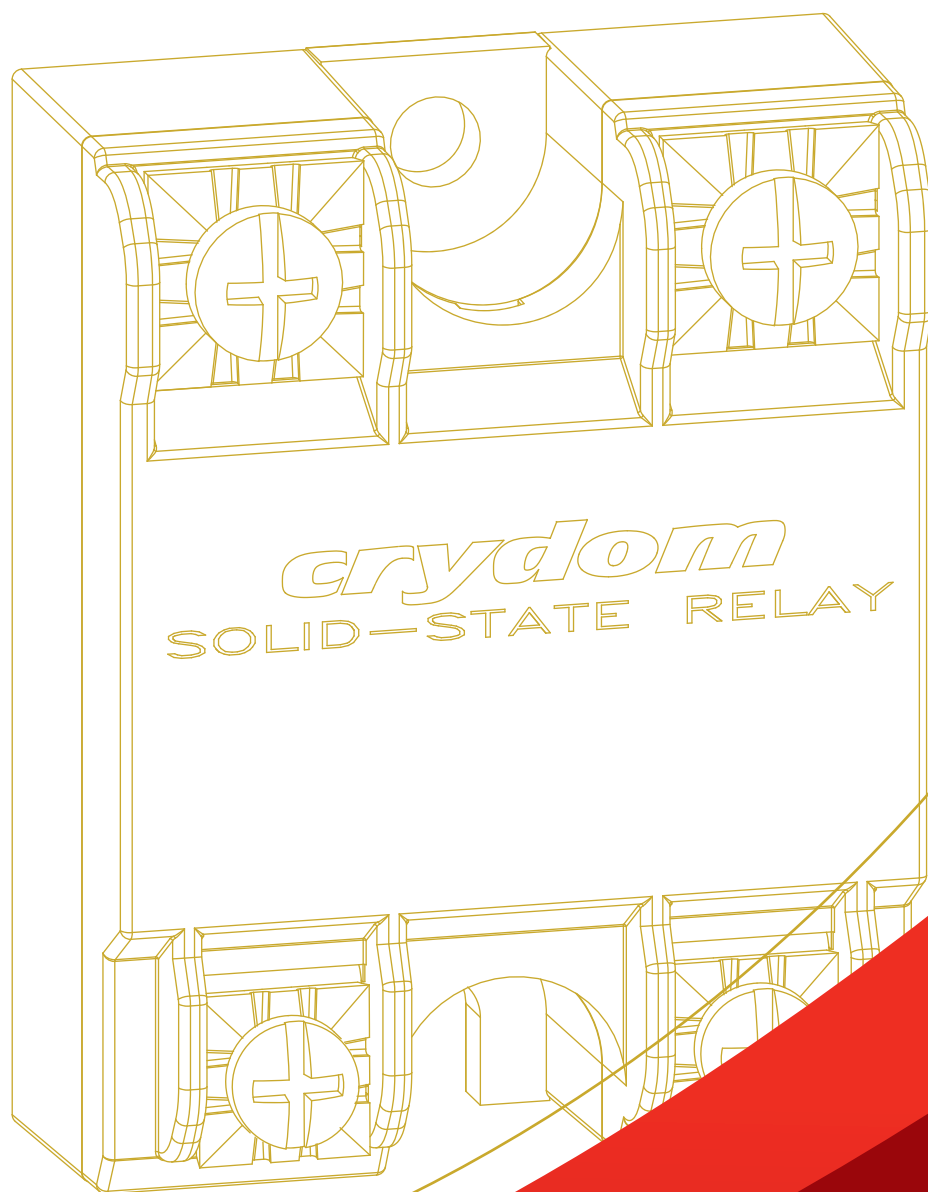

Panel Mount Solid State Relays Vol. II





Crydom, a brand of Custom Sensors & Technologies (CST) and **global expert in Solid State Relay Technology**, has a distinguished record of providing high quality, world class Solid State Relay and Control Products for a variety of heating, lighting and motion control applications. Crydom products, coupled with **unparalleled technical support, timely delivery and competitive pricing**, provide Crydom's clients with the innovative products and support necessary to succeed in today's competitive and fast paced global markets.

Crydom's extensive selection of standard off the shelf products is constantly being updated and expanded through its continuous improvement and aggressive new product development programs. Utilizing state of the art designs, materials and technology, Crydom offers a wide range of AC and DC output SSRs and solid state contactors in industry standard Panel Mount, PCB Mount, DIN Rail

and Plug In packages, all **meeting global safety and standards agency requirements** such as CE, RoHS, UL, IEC, etc.

Bolstered by four decades of Solid State Relay operations experience, Crydom also specializes and encourages **adapted and fully custom-designed SSR products** for nearly any application where unique specifications and optimized performance are critical for success.

Crydom's modern purpose built **100,000 square foot manufacturing facility** houses all aspects of its ISO certified operation including Design and Development Engineering, Manufacturing Operations and Quality Assurance, Customer Service, Finance, Marketing and General Management, permitting close coordination of all aspects of Crydom's activities. Applications Engineering and Sales support are both performed in the field to provide Crydom's Customers with the unparalleled technical and commercial support.

Following rigid design guidelines and standards, Crydom products have set the bench mark for SSR performance and reliability world wide. In addition to **award winning designs**, Crydom has acquired an impressive list of **patents** related to SSRs and Solid State Controls, while continuing to develop new circuit and technology related inventions as part of **extensive R&D programs**.

To learn more about Crydom SSR technology and products, or how an alliance with Crydom can contribute to the success of your project, visit **www.crydom.com** or contact your authorized Crydom Distributor or Crydom Customer Service Representative today.

www.crydom.com

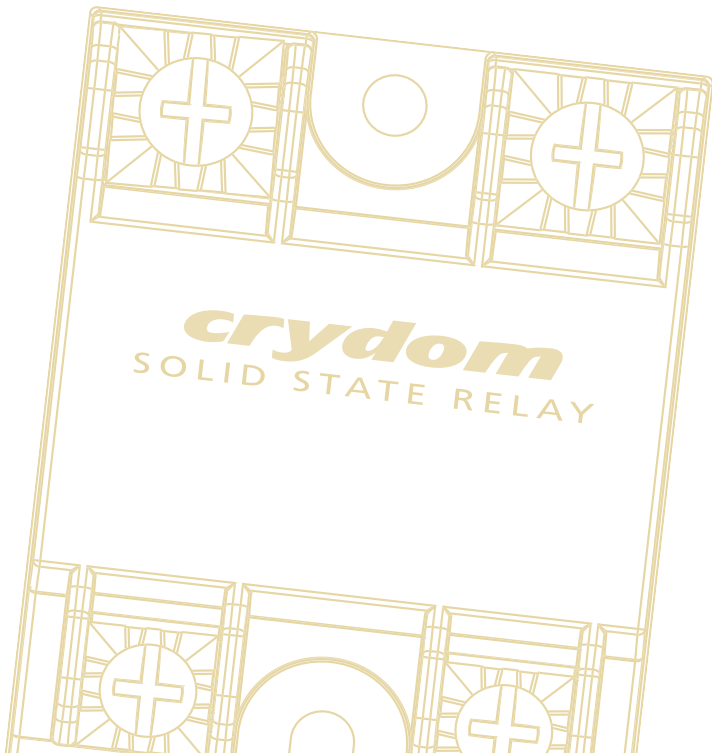

Custom Sensors & Technologies (CST) is a specialist in sensing, control and motion products.

Through its brands, **BEI Kimco, BEI Sensors, BEI PSSC, Crouzet, Crydom, Kavlico, Newall** and **Systron Donner Inertial**, CST offers customizable, reliable and efficient components for mission critical systems in Aerospace & Defense, Transportation, Energy & Infrastructure, Medical, Food and Beverage and Building Equipment markets.

Focused on premium value offers and committed to excellence, CST, with 4,500 employees worldwide and sales of \$600M US in 2013, is the dependable and adaptable partner for the most demanding customers.

www.cstsensors.com



The New EXPANDED range of S1 Generation 4 PANEL MOUNT SOLID STATE RELAYS

Now including DC Outputs & IP20 covers

New housing with anti-rotation barriers



Improved IP00 touch safe cover



Improved IP20 safety cover



Direct output "lead frame" termination



Improved thermal performance with DBC

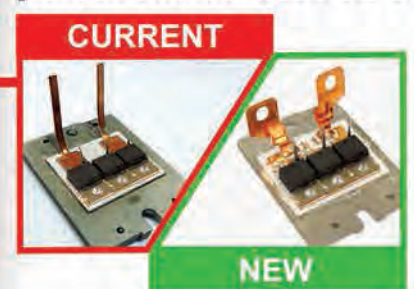

Improved "SEMS" screw & washer hardware

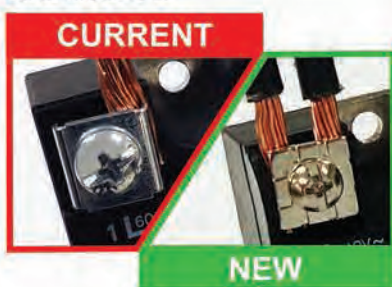

Stress & epoxy free construction



Improved performance

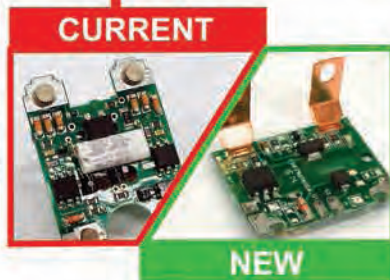



CW Series 280/660 VAC 10-125 Amps

- Heavy duty Solid State Relays
- Ratings from 10 to 125 Amps @ 24-280 VAC or 48-660 VAC
- AC or DC control and Universal AC/DC control
- SCR Output for heavy industrial loads
- UL/CSA/TUV Approved, CE Compliant to EN60950-1
- Certified according to EN 62314:2006



Output Specifications (A)	CWx2410	CWx2425	CWx2450	CWx2490	CWx24125	CWx4810	CWx4825	CWx4850	CWx4890	CWx48125
Operating Voltage (47-440Hz) [Vrms]	24-280	24-280	24-280	24-280	24-280	48-660	48-660	48-660	48-660	48-660
Transient Voltage [Vpk]	600	600	600	600	600	1200	1200	1200	1200	1200
Maximum 1 Cycle Surge Current (50/60Hz) [Apk]	380/400	570/600	810/850	1290/1350	1900/2000	380/400	570/600	810/850	1290/1350	1900/2000
Thermal Resistance Junction to Case (Rjc) [°C/W]	0.35	0.35	0.2	0.14	0.13	0.7	0.45	0.35	0.27	0.22
HP Rating UL 508/IEC60947 [HP] (KW): 120 VAC	0.5 (0.37)	0.75 (0.56)	1 (.74)	2 (1.5)	3 (2.24)	0.5 (0.37)	0.75 (0.56)	1 (.74)	2 (1.5)	3 (2.24)
HP Rating UL 508/IEC60947 [HP] (KW): 240 VAC	1.5 (1.1)	2 (1.5)	3 (2.2)	5 (3.73)	7.5(5.6)	1.5 (1.1)	2 (1.5)	3 (2.2)	5 (3.73)	7.5(5.6)
HP Rating UL 508/IEC60947 [HP] (KW): 480 VAC	-	-	-	-	-	3 (2.24)	5 (3.7)	7.5 (5.6)	10 (7.4)	15 (11.2)

Output Specifications (A)	10 A	25 A	50 A	90 A	125 A
Maximum Off-State Leakage Current @ Rated Voltage [mArms]	1	1	1	1	1
Minimum Off-State dv/dt @ Maximum Rated Voltage [V/usec]	500	500	500	500	500
Maximum Load Current [Arms] (B)	10	25	50	90	125
Minimum Load Current [mArms]	150	150	150	250	250
Maximum On-State Voltage Drop @ Rated Current [Vpk]	1.3	1.3	1.3	1.3	1.25
Maximum 1/2 Cycle I ² t for Fusing (50/60Hz) [A ² sec]	720/660	1620/1500	3280/3000	8320/7560	18000/16600
Minimum Power Factor (at Maximum load)	0.5	0.5	0.5	0.5	0.5

Input Specifications (A)	CWD	CWA	CWAxxxxE	CWU
Control Voltage Range	3-32 VDC [suffix 24] / 4-32 VDC [suffix 48]	90-280 VAC (D)	18-36 VAC	20-48 VDC/ 20-280 VAC
Maximum Reverse Voltage	-32 VDC	-	-	-
Minimum Turn-On Voltage	3 VDC [suffix 24] / 4 VDC [suffix 48] (C)	90 VAC	18 VAC	19 VDC/ VAC
Minimum Turn-Off Voltage	1 VDC	10 VAC	4 VAC	5 VDC/ VAC
Minimum Input Current (for on-state) [mA]	10	6	13	7/13
Maximum Input Current [mA]	15	10	15	11/9
Nominal Input Impedance [Ohms]	Current Regulated			
Maximum Turn-On Time [msec]	1/2 Cycle (E)	20	20	20
Maximum Turn-Off Time [msec]	1/2 Cycle	30	30	30

General Specifications (A)	CW Series
Dielectric Strength, Input/Output/Base (50/60Hz) [Vrms]	4000
Minimum Insulation Resistance (@ 500 VDC) [Ohms]	10 ⁹
Maximum Capacitance, Input/Output [pF]	8
Ambient Operating Temperature Range [°C] (F)	-40 to 80
Ambient Storage Temperature Range [°C]	-40 to 125
LED Input Status Indicator	Yes, Green
Weight (Typical) [oz] (gr)	2.88 (81.53)
Housing Material	UL94 V-0
Baseplate Material	Aluminum
Humidity	85% non-condensing
MTBF (Mean Time Between Failures) at 40°C ambient temperature (G)	11,641,553 hours (1,328 years)
MTBF (Mean Time Between Failures) at 60°C ambient temperature (G)	7,210,376 hours (823 years)

Part Number Nomenclature

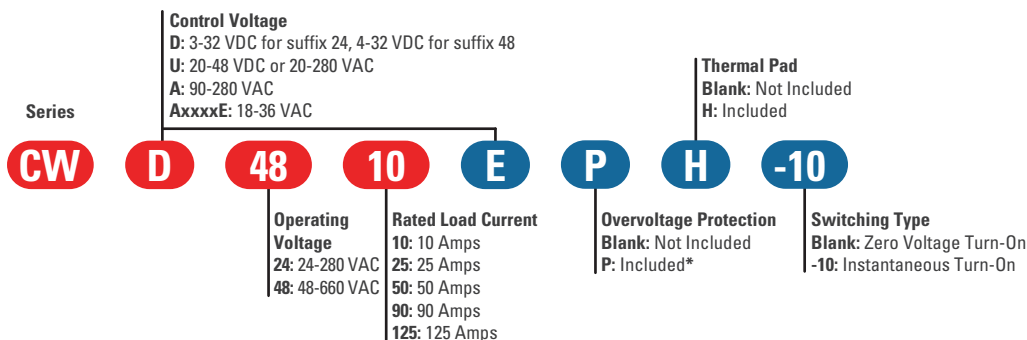

● Required for valid part number
 ● For options only and not required for valid part number

* Relay will self trigger between 900-1200Vpk.
 Not suitable for Capacitive Loads.

IEC 61000-4-2 Electrostatic Discharge Level 3
 IEC 61000-4-4 Electrically Fast Transients Level 3
 IEC 61000-4-5 Electrical Surges Level 3



CL Series 280 VAC 5-10 Amps

- Economical Solid State Relays with triac output
- Ratings of 5 and 10 Amps @ 280 VAC
- Flexible 3 to 32 VDC or 90 to 250 VAC Control Voltage
- New "K" Option for PCB mounting for IP00 versions
- UL Approved, CE Compliant to EN60950-1
- Optional IP20 safety cover



Output Specifications (A)

	5 A	10 A
Operating Voltage (47-63Hz) [Vrms]	24-280	24-280
Transient Overvoltage [Vpk] (H)	600	600
Maximum Off-State Leakage Current @ Rated Voltage [mA]	7	7
Minimum Off-State dv/dt @ Maximum Rated Voltage [V/μsec]	500	500
Maximum Load Current [Arms] (B)	5	10
Minimum Load Current [mA]	150	150
Maximum 1 Cycle Surge Current (50/60Hz) [Apk]	42/50	84/100
Maximum On-State Voltage Drop @ Rated Current [Vpk]	1.8	1.5
Thermal Resistance Junction to Case [Rjc] [°C/W]	3	2.5
Maximum 1/2 Cycle P t for Fusing (50/60Hz) [A² sec]	9/10	35/42
Minimum Heat Sink for Rated Current @ 40°C [°C/W]	3	1.5

Input Specifications (A)

	AC Input	DC Input
Control Voltage Range	90-250 VAC	3-32 VDC (C)
Maximum Reverse Voltage	N/A	-32 VDC
Minimum Turn-On Voltage	90 VAC	3 VDC
Must Turn-Off Voltage	10 VAC	1 VDC
Minimum Input Current (for on-state) [mA]	6	10
Maximum Input Current [mA]	10	15
Nominal Input Impedance [Ohms]	Current Limited	Current Limited
Maximum Turn-On Time [msec]	20	1/2 Cycle (E)
Maximum Turn-Off Time [msec]	30	1/2 Cycle

General Specifications (A)

	CL Series
Dielectric Strength, Input to Output (50/60Hz) [Vrms]	4000
Dielectric Strength, Input/Output to Ground (50/60Hz)	2500
Minimum Insulation Resistance (@ 500 VDC) [Ohms]	10 ⁹
Maximum Capacitance, Input/Output [pF]	8
Ambient Operating Temperature Range [°C] (F)	-40 to 80
Ambient Storage Temperature Range [°C]	-40 to 125
LED Input Status Indicator	Yes, Green
Weight (Typical) [oz] (gr)	2.88 (81.53)
Housing Material	UL94 V-0
Baseplate Material	Aluminum
Humidity	85% non-condensing
MTBF (Mean Time Between Failures) at 40°C ambient temperature (G)	11,641,553 hours (1,328 years)
MTBF (Mean Time Between Failures) at 60°C ambient temperature (G)	7,210,376 hours (823 years)

Part Number Nomenclature

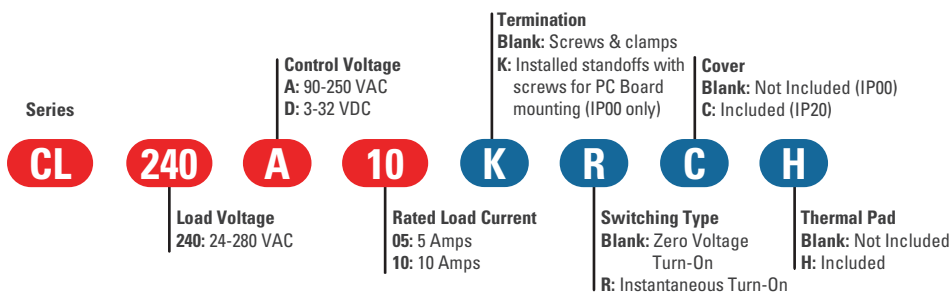

- Required for valid part number
- For options only and not required for valid part number

IEC 61000-4-2 Electrostatic Discharge Level 3
IEC 61000-4-4 Electrically Fast Transients Level 3
IEC 61000-4-5 Electrical Surges Level 3

Questions?
Call or e-mail:

America Tel.: +1 (877) 502 5500
e-mail: sales@crydom.com

EMEA Tel.: +44 (0) 1202 606030
e-mail: sales-europe@crydom.com

Asia Tel.: +86 (0) 21 6065 7725
e-mail: sales-cn@crydom.com



DC60 Series 60 VDC 3-7 Amps

- Economical Bipolar transistor output Solid State Relays
- Ratings from 3 to 7 Amps @ 60 VDC
- Flexible 3.5 to 32 VDC or 90 to 280 VAC/VDC Control Voltage
- New "K" Option for PCB mounting for IP00 versions
- UL Approved, CE Compliant to EN60950-1



Output Specifications (A)

	3 A	5 A	7 A
Recommended Operating Voltage [VDC]	3-48	3-48	3-48
Absolute Maximum Rating [VDC]	60	60	60
Maximum Off-State Leakage Current @ Rated Voltage [mA]	0.1	0.1	0.1
Maximum Load Current [Adc] (B)	3	5	7
Minimum Load Current [mA]	20	20	20
Maximum Surge Current [Adc] (10 ms)	6	10	14
Maximum On-State Voltage Drop @ Rated Current [VDC]	1.0	1.2	1.3
Thermal Resistance Junction to Case [Rjc] [°C/W]	2	2	2

Input Specifications (A)

	DC60Sx	DC60SAx
Control Voltage Range	3.5-32 VDC	90-280 VAC/ VDC
Maximum Reverse Voltage	-32 VDC	N/A
Minimum Turn-On Voltage (J)	3.5 VDC	90 VAC/VDC
Minimum Turn-Off Voltage (K)	1 VDC	10 VAC/VDC
Minimum Input Current (for on-state) [mA]	2.2	2
Maximum Input Current [mA]	25	5.5
Nominal Input Impedance [Ohms]	1500	60 K
Maximum Turn-On Time [msec] (L)	0.1	10
Maximum Turn-Off Time [msec] (M)	0.3	40

General Specifications (A)

	DC60 Series
Dielectric Strength, Input/Output/Base (50/60Hz) [Vrms]	4000
Minimum Insulation Resistance (@ 500 VDC) [Ohms]	10 ⁹
Maximum Capacitance, Input/Output [pF]	8
Ambient Operating Temperature Range [°C]	-30 to 80
Ambient Storage Temperature Range [°C]	-40 to 125
Weight (Typical) [oz] (gr)	2.83 (80)
Housing Material	UL94 V-0
Baseplate Material	Aluminum
Humidity	85% non-condensing
MTBF (Mean Time Between Failures) at 40°C ambient temperature (G)	21,395,130 hours (2,441 years)
MTBF (Mean Time Between Failures) at 60°C ambient temperature (G)	11,545,504 hours (1,317 years)

Part Number Nomenclature

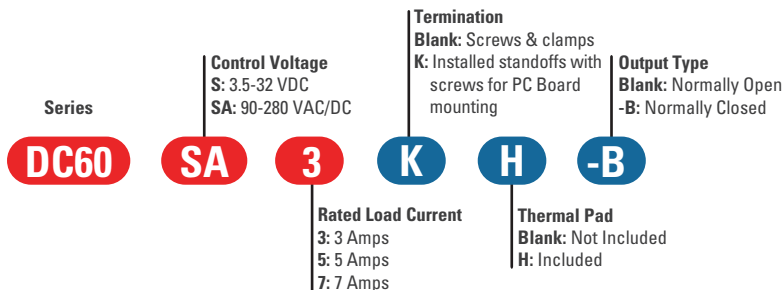

- Required for valid part number
- For options only and not required for valid part number



D06D Series

60 VDC
60-100 Amps

- Solid State Relays with low impedance MOSFET output
- Ratings from 60 to 100 Amps @ 60 VDC
- Flexible 3.5 to 32 VDC Control Voltage
- New "K" Option for PCB mounting for IP00 versions
- UL Approved, CE Compliant to EN60950-1



Output Specifications (A)

	60 A	80 A	100 A
Recommended Operating Voltage [VDC]	1-48	1-48	1-48
Absolute Maximum Rating [VDC]	60	60	60
Maximum Off-State Leakage Current @ Rated Voltage [mA]	0.5	0.5	0.8
Maximum Load Current [A] (B)	60	80	100
Minimum Load Current [mA] (N)	5	5	5
Maximum Surge Current [A] (10 ms)	124	156	238
Maximum On-State Voltage Drop @ Rated Current [VDC]	1.00	1.10	0.85
Maximum On-State Resistance [R _{DS-ON}] [Ohms]	0.016	0.013	0.0085
Thermal Resistance Junction to Case [R _{jc}] [°C/W]	1.00	0.75	0.60
Minimum Heat Sink for Rated Current @ 40°C [°C/W]	1.0	0.5	0.5
Maximum Pulse Wide Modulation Frequency [Hz] (P)	1000	900	700

Input Specifications (A)

	D06D Series
Control Voltage Range [VDC]	3.5-32
Maximum Reverse Voltage [VDC]	-32
Minimum Turn-On Voltage [VDC] (C)	3.5
Must Turn-Off Voltage [VDC]	1
Minimum Input Current (for on-state) [mA]	10
Maximum Input Current [mA]	15
Nominal Input Impedance	Current Regulated
Maximum Turn-On Time [µsec]	100
Maximum Turn-Off Time [µsec]	150

General Specifications (A)

	D06D Series
Dielectric Strength, Input/Output/Base (50/60Hz) [Vrms]	3750
Minimum Insulation Resistance (@ 500 VDC) [Ohms]	10 ⁹
Maximum Capacitance, Input/Output [pF]	8
Ambient Operating Temperature Range [°C] (D)	-40 to 100
Ambient Storage Temperature Range [°C]	-40 to 125
Weight (Typical) [oz] (gr)	2.83 (80)
Housing Material	UL94 V-0
Baseplate Material	Aluminum
Humidity	85% non-condensing
MTBF (Mean Time Between Failures) at 40°C ambient temperature (G)	21,395,130 hours (2,441 years)
MTBF (Mean Time Between Failures) at 60°C ambient temperature (G)	11,545,504 hours (1,317 years)

Part Number Nomenclature

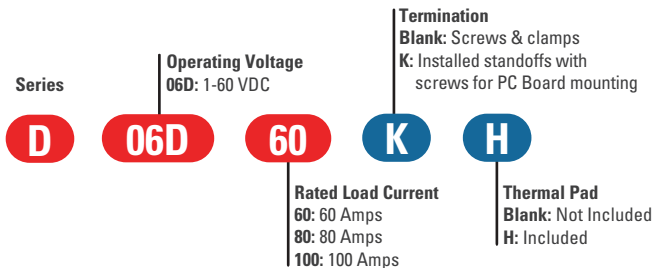

- Required for valid part number
- For options only and not required for valid part number

IEC 61000-4-2 Electrostatic Discharge Level 3
IEC 61000-4-4 Electrically Fast Transients Level 3
IEC 61000-4-5 Electrical Surges Level 3

Questions?
Call or e-mail:

America Tel.: +1 (877) 502 5500
e-mail: sales@crydom.com

EMEA Tel.: +44 (0) 1202 606030
e-mail: sales-europe@crydom.com

Asia Tel.: +86 (0) 21 6065 7725
e-mail: sales-cn@crydom.com



Series 1-DC & 1-DCL

100/200/400/500 VDC

7-100 Amps

- Solid State Relays with low impedance MOSFET output
- Ratings from 7 to 100 Amps @ 100 VDC, from 7 to 40 Amps @ 200 VDC, from 7 to 12 Amps @ 400 VDC, and from 7 to 10 Amps @ 500 VDC
- Flexible 3.5 to 32 VDC Control Voltage
- New "K" Option for PCB mounting for IP00 versions
- UL Approved, CE Compliant to EN60950-1



Output Specifications (A)	D1D07x	D1D12x	D1D20x	D1D40x	D1D60x	D1D80x	D1D100x	D2D07x	D2D12x	D2D40x	D4D07x	D4D12x	D5D07x	D5D10x
Recommended Operating Voltage [VDC]	1-72	1-72	1-72	1-72	1-72	1-72	1-72	1-150	1-150	1-150	1-300	1-300	1-385	1-385
Absolute Maximum Rating [VDC]	100	100	100	100	100	100	100	200	200	200	400	400	500	500
Maximum Off-State Leakage Current @ Rated Voltage [mA]	0.1	0.2	0.3	0.3	0.1	0.2	0.3	0.1	0.3	0.3	0.3	0.3	0.2	0.3
Maximum Load Current [A] (B)	7	12	20	40	60	80	100	7	12	40	7	12	7	10
Minimum Load Current [mA] (N)	1	1	1	1	5	5	5	1	1	1	1	1	1	1
Maximum Surge Current [A] (10 ms)	23	28	42	89	180	220	330	22	31	106	18	36	19	29
Maximum On-State Voltage Drop @ Rated Current [VDC]	1.0	1.3	1.4	1.4	0.820	0.850	0.800	2.3	1.5	1.6	4.3	4.9	5.7	5.5
Maximum On-State Resistance [R _{DS-ON}] [Ohms]	0.14	0.11	0.07	0.034	0.014	0.011	0.008	0.33	0.12	0.04	0.6	0.41	0.8	0.55
Thermal Resistance Junction to Case [R _{jc}] [°C/W]	2.20	2.00	1.71	0.70	0.45	0.34	0.27	1.25	0.72	0.26	0.70	0.44	0.60	0.43
Minimum Heat Sink for Rated Current @ 40°C [°C/W]	5.0	3.0	2.0	1.0	1.0	0.5	0.5	3.0	3.0	0.7	2.0	1.0	1.0	0.7
Maximum Pulse Wide Modulation Frequency [Hz] (P)	5000	4000	3500	2500	1000	900	800	3500	2000	950	1200	900	1100	900

Input Specifications (A)

	Series 1-DC & 1-DCL
Control Voltage Range [VDC]	3.5-32
Maximum Reverse Voltage [VDC]	-32
Minimum Turn-On Voltage [VDC] (C)	3.5
Must Turn-Off Voltage [VDC]	1
Minimum Input Current (for on-state) [mA]	10
Maximum Input Current [mA]	15
Nominal Input Impedance	Current Regulated
Maximum Turn-On Time [µsec]	100
Maximum Turn-Off Time [µsec]	100

General Specifications (A)

	Series 1-DC & 1-DCL
Dielectric Strength, Input/Output/Base (50/60Hz) [Vrms]	3750
Minimum Insulation Resistance (@ 500 VDC) [Ohms]	10 ⁹
Maximum Capacitance, Input/Output [pF]	8
Ambient Operating Temperature Range [°C] (Q)	-40 to 100
Ambient Storage Temperature Range [°C]	-40 to 125
Weight (Typical) [oz] (gr)	2.83 (80)
Housing Material	UL94 V-0
Baseplate Material	Aluminum
Humidity	85% non-condensing
MTBF (Mean Time Between Failures) at 40°C ambient temperature (G)	21,395,130 hours (2,441 years)
MTBF (Mean Time Between Failures) at 60°C ambient temperature (G)	11,545,504 hours (1,317 years)

Part Number Nomenclature

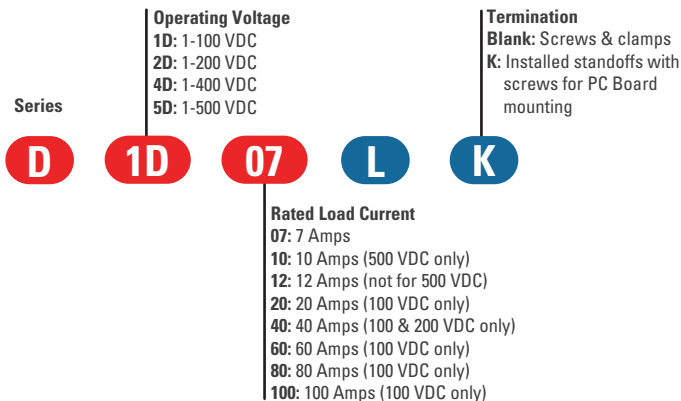

- Required for valid part number
- For options only and not required for valid part number

IEC 61000-4-2 Electrostatic Discharge Level 3
 IEC 61000-4-4 Electrically Fast Transients Level 3
 IEC 61000-4-5 Electrical Surges Level 3



SSC Series 1000 VDC 25 Amps

- Solid State Relays with high voltage IGBT output
- Rated at 25 Amps @ 1000 VDC
- Flexible 8 to 16 VDC or 20 to 28 VDC Control Voltage
- New "K" Option for PCB mounting for IP00 versions
- UL Approved, CE Compliant to EN60950-1



Output Specifications (A)

	SSC Series
Recommended Operating Voltage [VDC]	1-1000
Absolute Maximum Rating [VDC]	1000
Maximum Off-State Leakage Current @ Rated Voltage [mA]	0.3
Maximum Load Current [A] (B)	25
Minimum Load Current [mA] (N)	20
Maximum Surge Current [A] (10 ms)	75
Maximum On-State Voltage Drop @ Rated Current [VDC]	1.8
Thermal Resistance Junction to Case [Rjc] [°C/W]	0.45
Minimum Heat Sink for Rated Current @ 40°C [°C/W]	1
Maximum Pulse Width Modulation Frequency [Hz] (P)	500

Input Specifications (A)

	Option -12	Option -24
Nominal Control Voltage [VDC]	12	24
Control Voltage Range [VDC]	8-16	20-28
Maximum Reverse Voltage [VDC]	-16	-28
Minimum Turn-On Voltage [VDC]	8	20
Must Turn-Off Voltage [VDC]		1
Minimum Input Current (for on-state) [mA]		12.5
Maximum Input Current [mA]		15
Nominal Input Impedance [Ohms]		Current Regulated
Maximum Turn-On Time [µsec]		200
Maximum Turn-Off Time [µsec]		150

General Specifications (A)

	SSC Series
Dielectric Strength, Input/Output/Base (50/60Hz) [Vrms]	3750
Minimum Insulation Resistance (@ 500 VDC) [Ohms]	10 ⁹
Maximum Capacitance, Input/Output [pF]	8
Ambient Operating Temperature Range [°C] (D)	-40 to 100
Ambient Storage Temperature Range [°C]	-40 to 125
Weight (Typical) [oz] (gr)	2.83 (80)
Housing Material	UL94 V-0
Baseplate Material	Aluminum
Humidity	85% non-condensing
MTBF (Mean Time Between Failures) at 40°C ambient temperature (G)	21,395,130 hours (2,441 years)
MTBF (Mean Time Between Failures) at 60°C ambient temperature (G)	11,545,504 hours (1,317 years)

Part Number Nomenclature

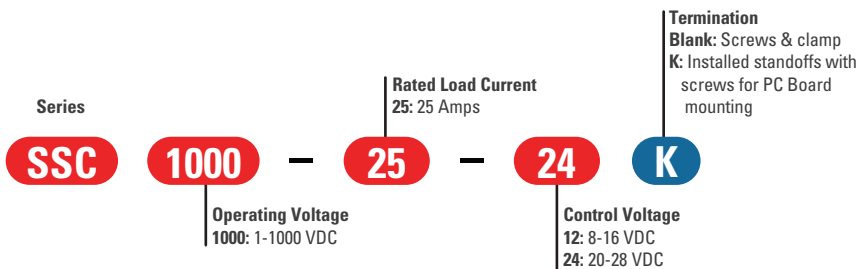

- Required for valid part number
- For options only and not required for valid part number



PowerPlus DC Series 60/100/200/400/500 VDC 10-100 Amps

- Solid State Relays with ratings up to 100 Amps @ 60 VDC, 100 Amps @ 100 VDC, 40 Amps @ 200 VDC, 20 Amps @ 400 VDC and 60 Amps @ 500 VDC
- Flexible 4 to 32 VDC or 30 to 60 VDC Control Voltage
- New "K" Option for PCB mounting for IP00 versions
- UL Approved, CE Compliant to EN60950-1
- Optional IP20 safety cover



Output Specifications (A)	DC60x10	DC60x20	DC60x40	DC60x60	DC60x80	DC60x100
Recommended Operating Voltage [VDC]	1-48	1-48	1-48	1-48	1-48	1-48
Absolute Maximum Rating [VDC]	60	60	60	60	60	60
Maximum Off-State Leakage Current @ Rated Voltage [mA]	0.25	0.25	0.5	0.5	0.8	0.8
Maximum Load Current [Adc] (B)	10	20	40	60	80	100
Minimum Load Current [mA] (N)	2.5	2.5	2.5	2.5	2.5	2.5
Maximum Surge Current [Adc] (10 ms)	38	72	89	124	156	238
Maximum On-State Voltage Drop @ Rated Current [VDC]	0.33	0.49	0.66	0.9	1.1	0.85
Maximum On-State Resistance [R _{DS-ON}] [Ohms]	0.033	0.022	0.017	0.015	0.013	0.0085
Thermal Resistance Junction to Case (Rjc) [°C/W]	1.61	1.61	1	0.78	0.75	0.55
Minimum Heat Sink for Rated Current @ 40°C [°C/W]	5	5	2	1	0.5	0.5
Maximum Pulse Wide Modulation Frequency [Hz] (P)	1000	1000	900	900	450	375

Output Specifications (A)	DC100x10	DC100x20	DC100x40	DC100x60	DC100x80	DC100x100
Recommended Operating Voltage [VDC]	1-72	1-72	1-72	1-72	1-72	1-72
Absolute Maximum Rating [VDC]	100	100	100	100	100	100
Maximum Off-State Leakage Current @ Rated Voltage [mA]	0.1	0.1	0.2	0.2	0.2	0.3
Maximum Load Current [Adc] (B)	10	20	40	60	80	100
Minimum Load Current [mA] (N)	2.5	2.5	2.5	2.5	2.5	2.5
Maximum Surge Current [Adc] (10 ms)	44	64	119	180	220	330
Maximum On-State Voltage Drop @ Rated Current [VDC]	0.33	0.37	0.63	0.82	0.84	0.7
Maximum On-State Resistance [R _{DS-ON}] [Ohms]	0.033	0.018	0.016	0.014	0.011	0.008
Thermal Resistance Junction to Case (Rjc) [°C/W]	1.27	0.73	0.58	0.45	0.34	0.27
Minimum Heat Sink for Rated Current @ 40°C [°C/W]	N/R	5	2	1	0.5	0.5
Maximum Pulse Wide Modulation Frequency [Hz] (P)	1000	1000	900	900	300	250

Output Specifications (A)	DC200x10	DC200x20	DC200x40	DC200x60	DC400x10	DC400x20	DC500x60
Recommended Operating Voltage [VDC]	1-150	1-150	1-150	1-150	1-300	1-300	1-500
Absolute Maximum Rating [VDC]	200	200	200	200	400	400	500
Maximum Off-State Leakage Current @ Rated Voltage [mA]	0.2	0.2	0.2	0.2	0.4	0.4	0.1
Maximum Load Current [Adc] (B)	10	20	40	60	10	20	60
Minimum Load Current [mA] (N)	2.5	2.5	2.5	2.5	2.5	2.5	2.5
Maximum Surge Current [Adc] (10 ms)	62	82	118	224	32	48	95
Maximum On-State Voltage Drop @ Rated Current [VDC]	0.77	1.2	1.05	1.1	3	3.8	0.8
Maximum On-State Resistance [R _{DS-ON}] [Ohms]	0.078	0.06	0.025	0.018	0.3	0.19	0.013
Thermal Resistance Junction to Case (Rjc) [°C/W]	1.2	0.76	0.43	0.32	0.5	0.37	0.25
Minimum Heat Sink for Rated Current @ 40°C [°C/W]	5	2.5	1	0.5	1.5	0.5	0.7
Maximum Pulse Wide Modulation Frequency [Hz] (P)	1000	1000	550	250	500	250	500

Input Specifications (A)	DC60xx	DC100xx	DC200xx	DC400xx	DC500Dx	DC500Fx
Control Voltage Range [VDC]	4-32	4-32	4-32	4-32	4-32	30-60
Maximum Reverse Voltage [VDC]	-32	-32	-32	-32	-32	-60
Minimum Turn-On Voltage [VDC] (C)	4	4	4	4	4	30
Must Turn-Off Voltage [VDC]	1	1	1	1	1	20
Minimum Input Current (for on-state) [mA]	11	11	11	11	11	12
Maximum Input Current [mA]	15	15	15	15	15	17
Nominal Input Impedance	Current Regulated					
Maximum Turn-On Time [µsec]	75	75	100	100	100	100
Maximum Turn-Off Time [µsec]	150	150	100	100	100	100

General Specifications (A)

PowerPlus DC Series

Dielectric Strength, Input/Output/Base (50/60Hz) [Vrms]	3750
Minimum Insulation Resistance (@ 500 VDC) [Ohms]	10 ⁹
Maximum Capacitance, Input/Output [pF]	8
Ambient Operating Temperature Range [°C] (Q)	-40 to 100
Ambient Storage Temperature Range [°C]	-40 to 125
LED Input Status Indicator	Yes, Green
Weight (Typical) [oz] (gr)	2.88 (81.53)
Housing Material	UL94 V-0
Baseplate Material	Aluminum
Humidity	85% non-condensing
MTBF (Mean Time Between Failures) at 40°C ambient temperature (G)	21,395,130 hours (2,441 years)
MTBF (Mean Time Between Failures) at 60°C ambient temperature (G)	11,545,504 hours (1,317 years)

Part Number Nomenclature

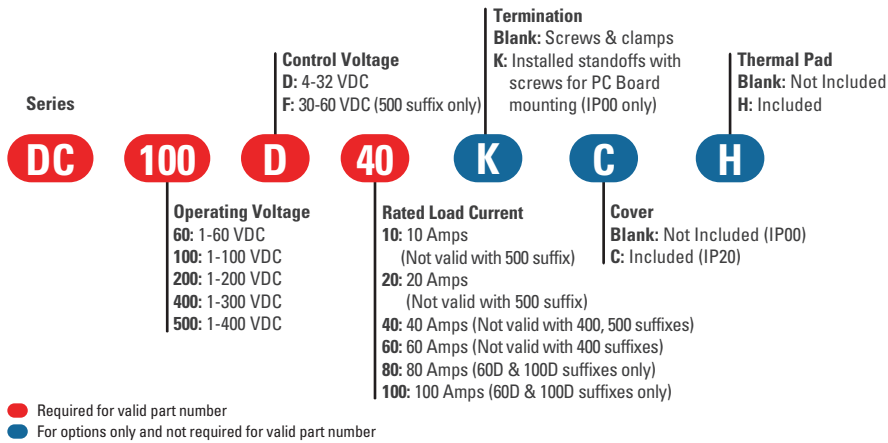

IEC 61000-4-2 Electrostatic Discharge Level 3
 IEC 61000-4-4 Electrically Fast Transients Level 3
 IEC 61000-4-5 Electrical Surges Level 3

General Notes

- (A) All parameters at 25°C unless otherwise specified.
- (B) Heat sinking required, see derating curves. For "K" option maximum current up to 50 Amp.
- (C) Increase minimum voltage by 1 V for operations from -20 to -40°C.
- (D) For ambient temperatures above 40°C the maximum control voltage must not exceed 250 VAC.
- (E) Turn-on time for Instantaneous turn-on versions is 0.1 msec for CWA, CWD & CL240D, and 7 ms for CWU models.
- (F) AC models operating range is -20 to 80 °C
- (G) All parameters at 50% power rating and 100% duty cycle (contact Crydom tech support for detailed report).
- (H) Output will self trigger between 450-600 Vpk, not suitable for capacitive loads.
- (J) Minimum turn-on voltage for -B, DC control is 1 VDC and AC control is 10 Vrms/VDC.
- (K) Minimum turn-off voltage for -B, DC control is 3.5 VDC and AC control is 90 Vrms/VDC.

- (L) Turn-on time for -B version is 300 µs
- (M) Turn-off time for -B version is 100 µs.
- (N) Low current loads and high ambient temperature can affect turn-on time.
- (P) 8 VDC Minimum control voltage. Resistive loads only. Consider switching losses; at maximum frequency reduce to 75% output current.
- (Q) Decrease maximum control voltage 1.35V/°C above 80°C ambient temperature.
- (R) Select "P" option for overvoltage protection.
- (S) Option "K" is intended only for use in attaching a printed circuit board to the SSR or mounting the SSR to a printed circuit board (PCB thicknesses from .031 to .093 inches [0.79 to 2.36 mm]).

Block Diagrams

Diagram 1: CW Series, AC Control

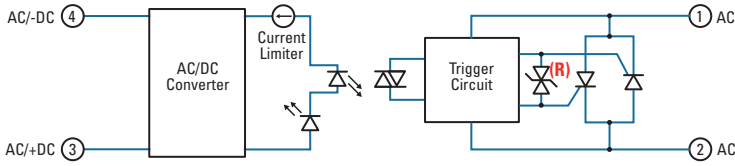

Diagram 2: CW Series, DC Control

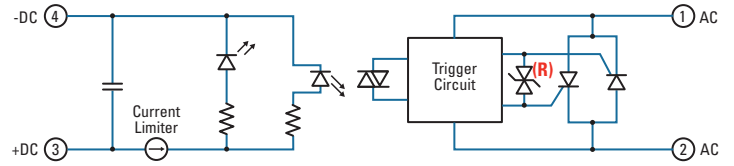

Diagram 3: CL Series, AC Control

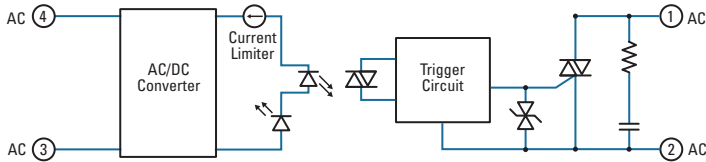

Diagram 4: CL Series, DC Control

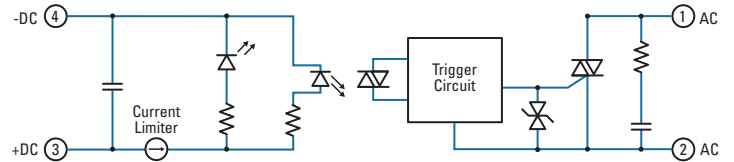

Diagram 5: DC60 Series AC Control

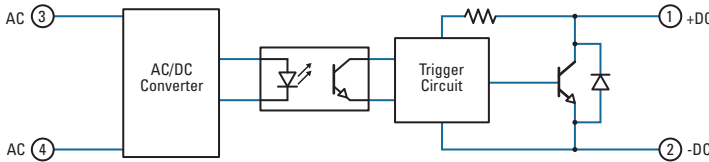

Diagram 6: DC60 Series, DC Control

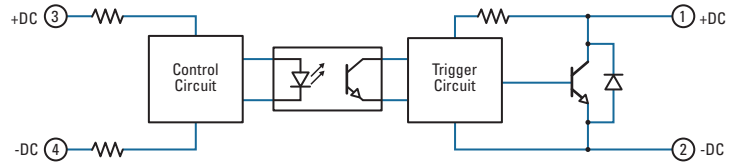

Diagram 7: 1-DC, 1-DCL, D1D, D06D Series

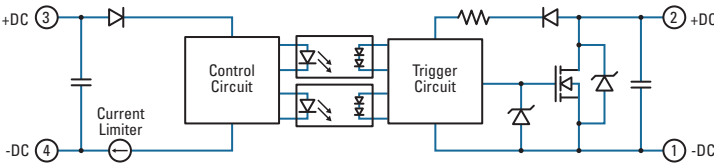

Diagram 8: SSC Series

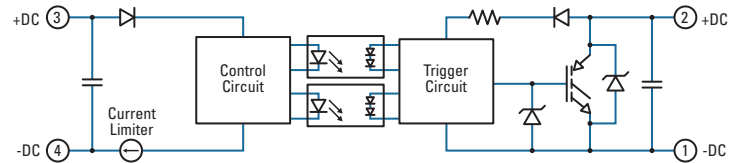

Diagram 9: PowerPlus DC Series

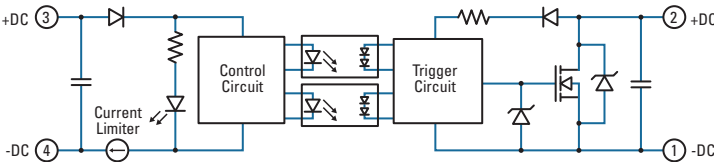
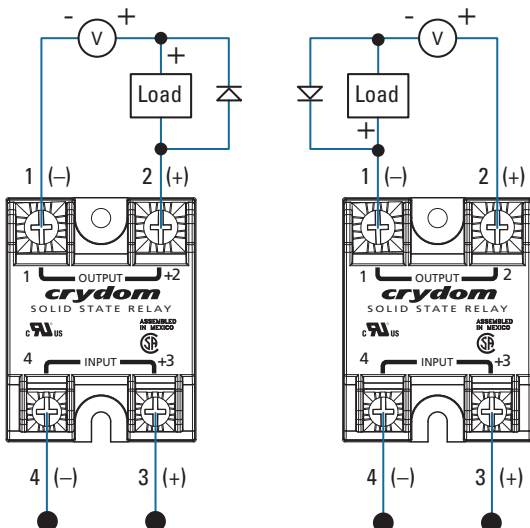

TABLE 1. Block Diagrams

Diagram 1	CW Series, AC Control
Diagram 2	CW Series, DC Control
Diagram 3	CL Series, AC Control
Diagram 4	CL Series, DC Control
Diagram 5	DC60 Series, AC Control
Diagram 6	DC60 Series, DC Control
Diagram 7	1-DC, 1-DCL, D1D, D06D Series
Diagram 8	SSC Series
Diagram 9	PowerPlus DC Series

Wiring Diagrams

All DC Output Relays, Except DC60Sx



DC60Sx

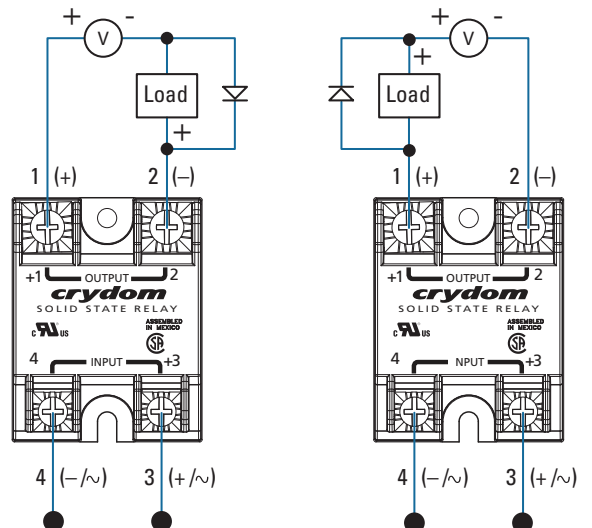

Wiring Diagrams

All AC Output Relays

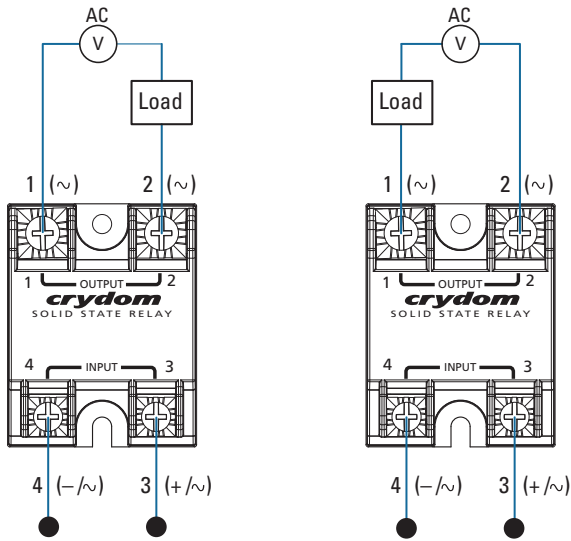

Mechanical Dimensions

Tolerances: 0.02 in / 0.5 mm
All dimensions are in: inches [millimeters]

Screw Termination

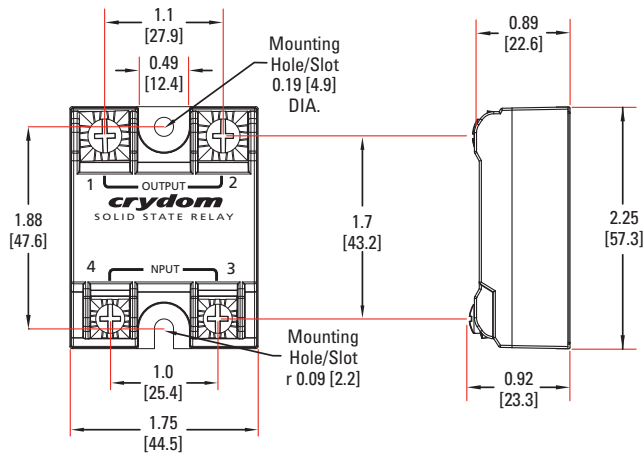

Standoff Termination (Option "K") (S)

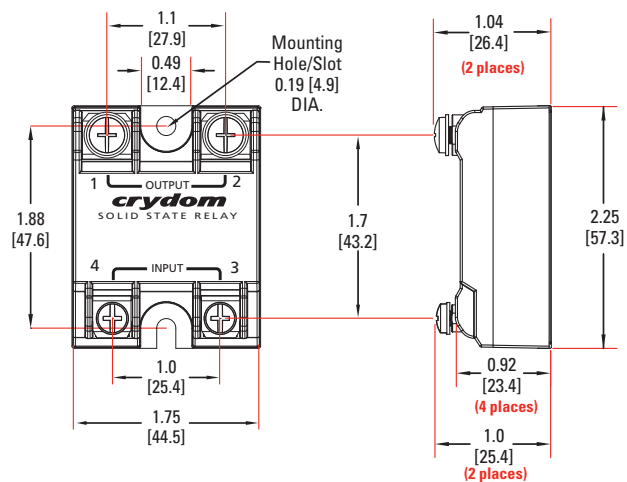

New Accessories!

Protective Cover & Hardware Kit

Protective Cover

Part number: KS101



Clear plastic cover compatible with all new S1 designs. Safety covers provide added protection from electric shock when installing or checking equipment. Not applicable for IP20 models (CW, CL & PowerPlus DC Series).

Hardware Kit

Part number: HK4



Bag with 2 square brass accessories and 2 screw 8-32 x 5/8 for output. Used to mount TMR1 lug terminals.

TABLE 2. Recommended Accessories

Cover	Hardware Kit	Heat Sink Part No.	Thermal Resistance [°C/W]	Lug Terminal	Thermal Pad
KS101	HK1	HS501DR	5.0	TRM1	HSP-1
		HK4	HS301 / HS301DR	3.0	TRM6
		HS251	2.5		
		HS201 / HS201DR	2.0		
		HS202 / HS202DR	2.0		
		HS172	1.7		
		HS151 / HS151DR	1.5		
		HS122 / HS122DR	1.2		
		HS103 / HS103DR	1.0		
		HS101	1.0		
		HS073	0.7		
		HS072	0.7		
		HS053	0.5		
		HS033	0.36		
	HS023	0.25			

Screw Termination, IP20 (Option "C" & CW Series)

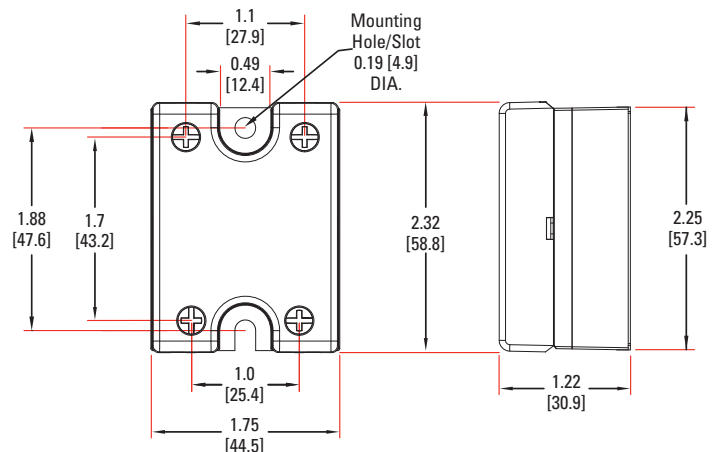

Questions?
Call or e-mail:

America Tel.: +1 (877) 502 5500
e-mail: sales@crydom.com

EMEA Tel.: +44 (0) 1202 606030
e-mail: sales-europe@crydom.com

Asia Tel.: +86 (0) 21 6065 7725
e-mail: sales-cn@crydom.com

Derating Curves: CW Series

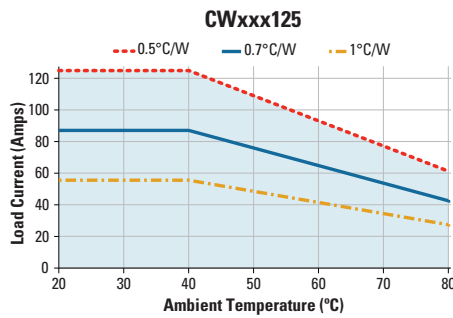
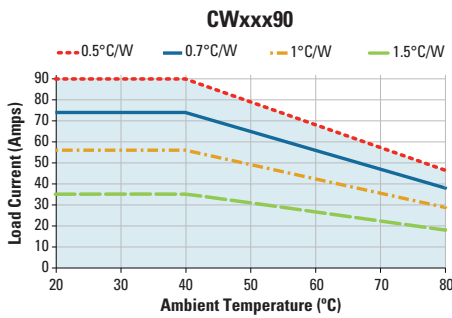
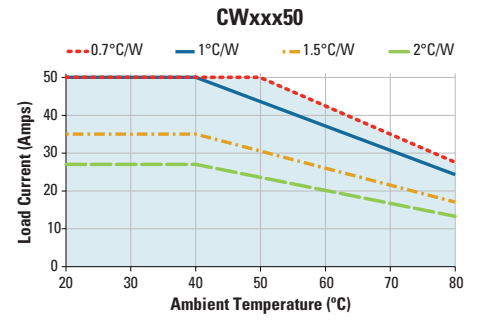
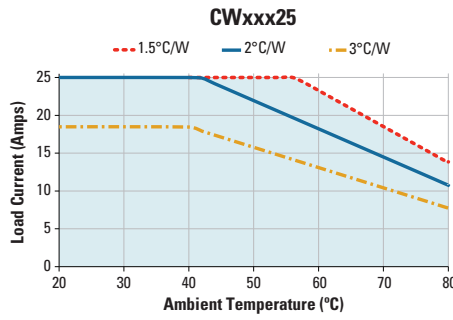
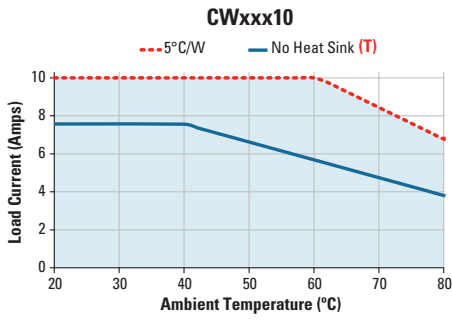

Derating Curves: CL Series

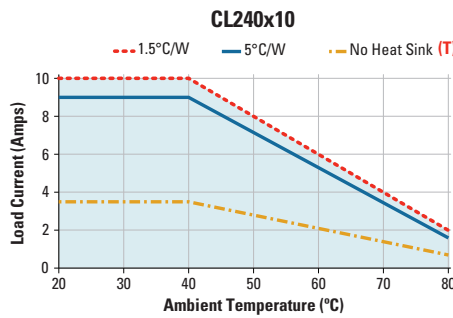
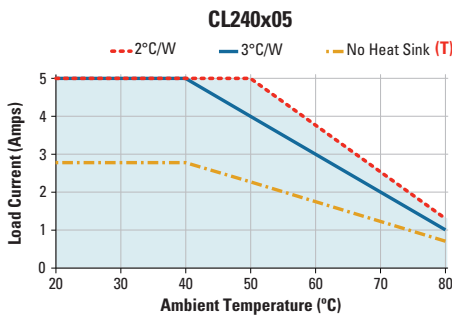

Derating Curves: DC60 Series

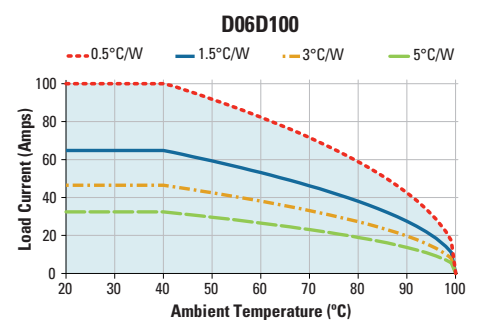
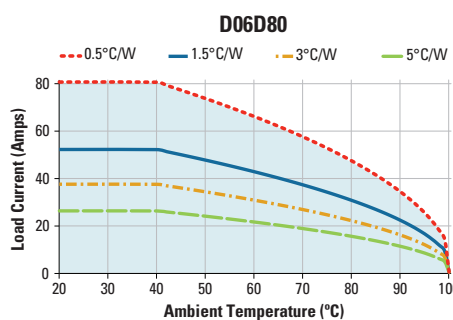
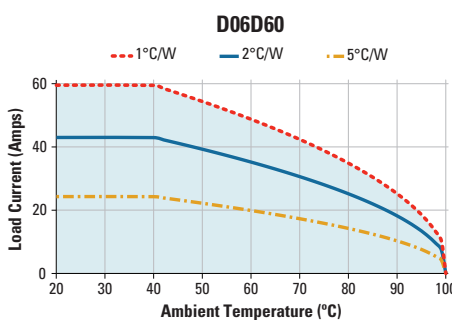
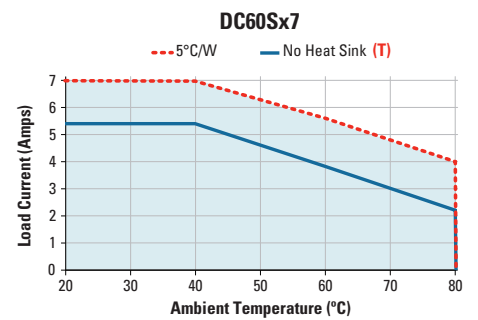
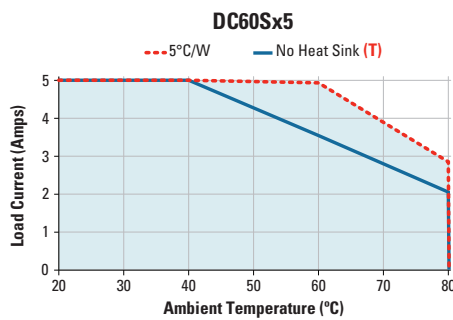
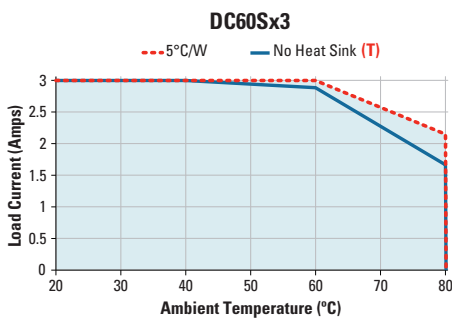

Derating Curves: Series 1-DC & 1-DCL

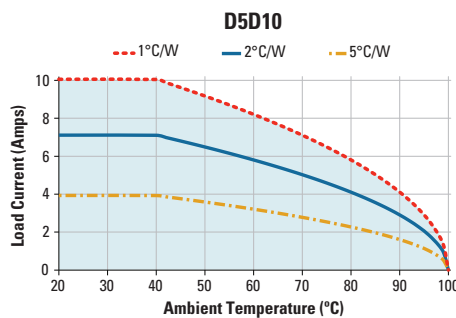
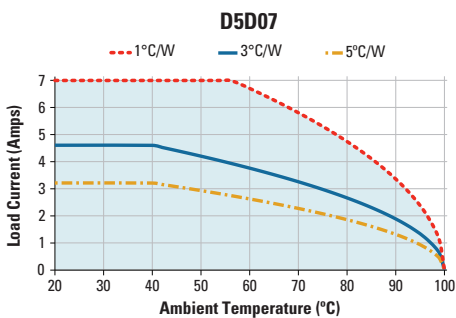
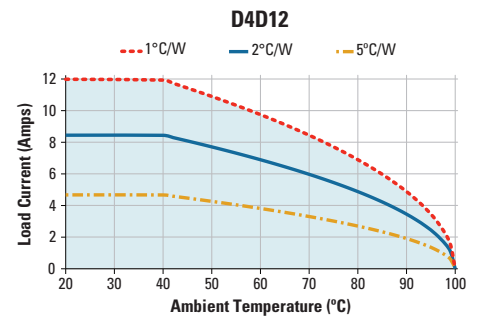
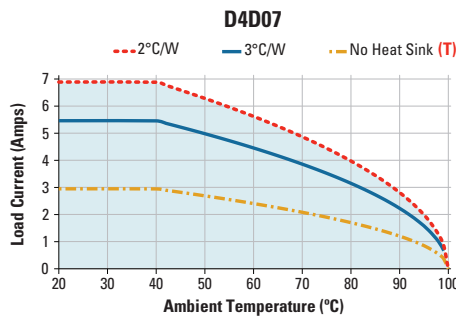
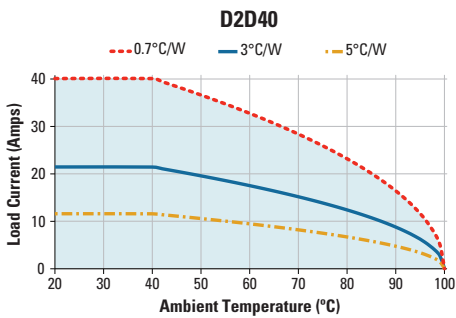
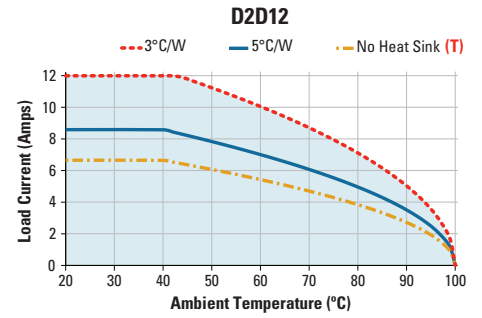
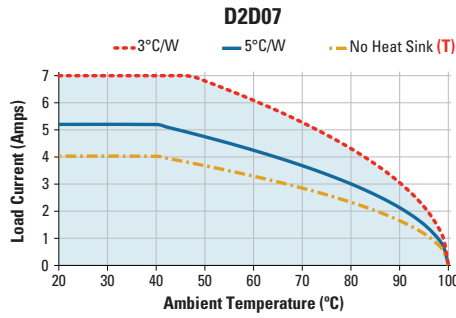
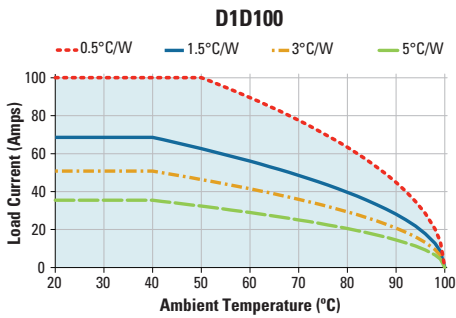
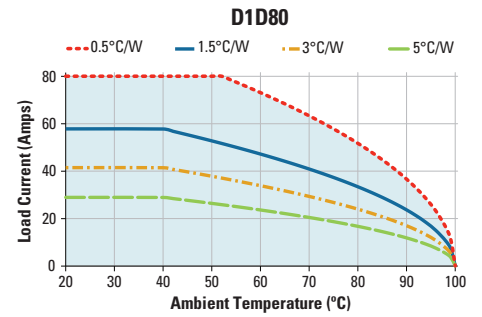
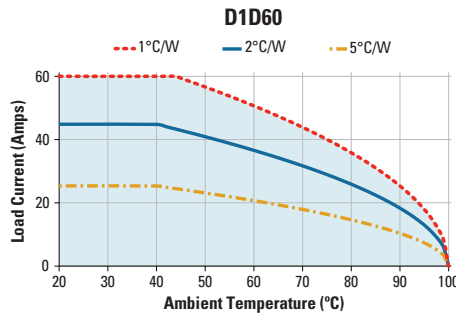
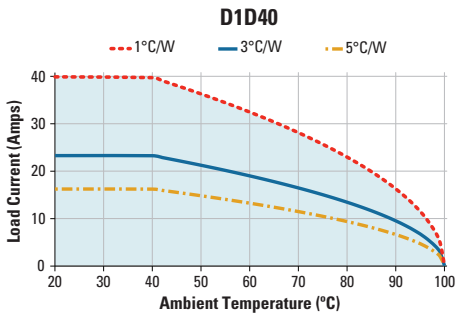
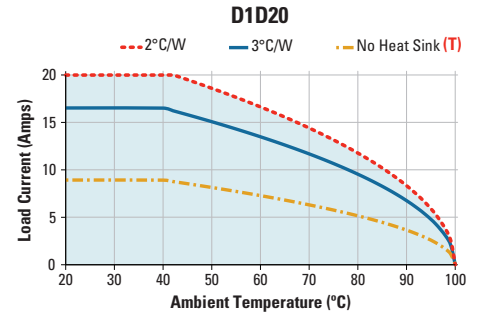
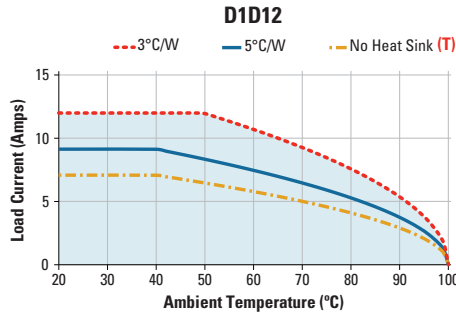
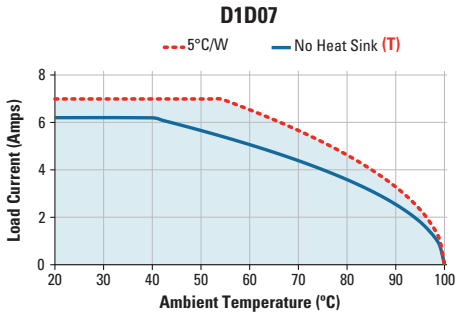

Derating Curves: SSC Series

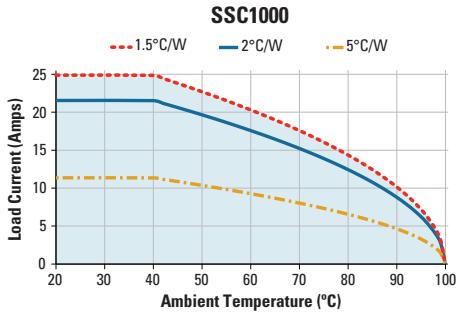

Derating Curves: PowerPlus DC Series

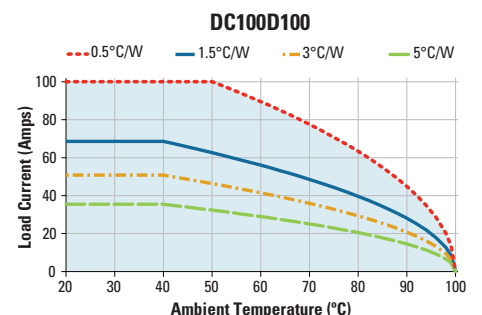
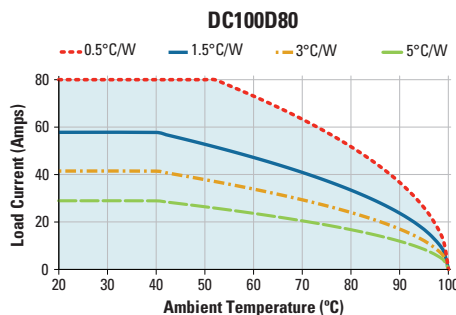
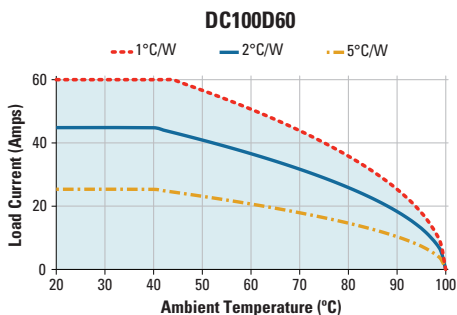
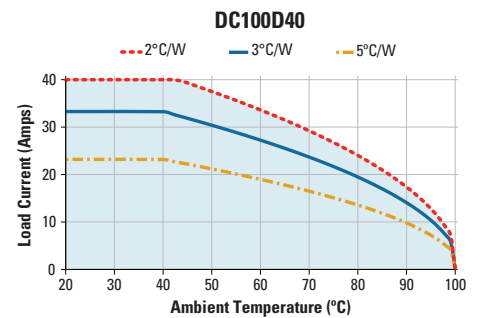
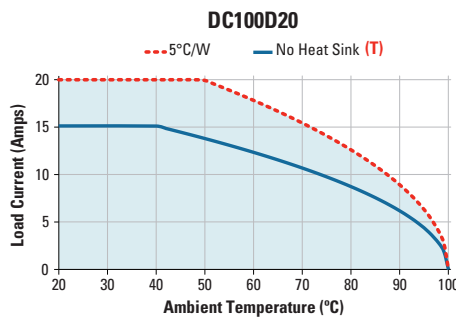
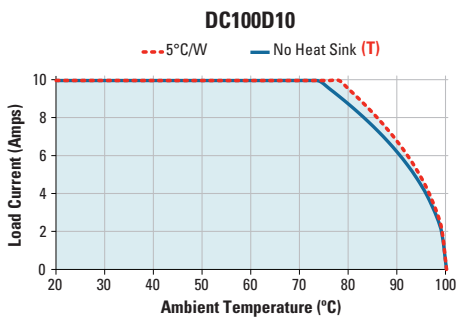
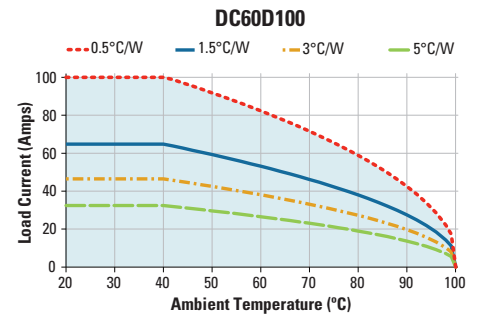
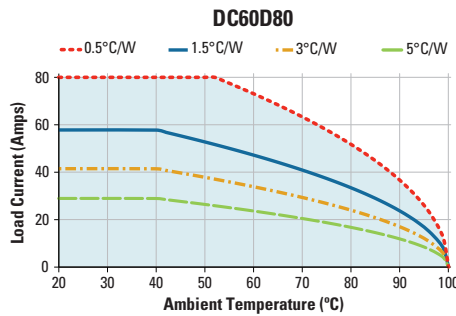
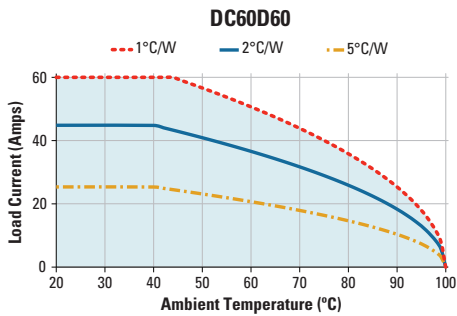
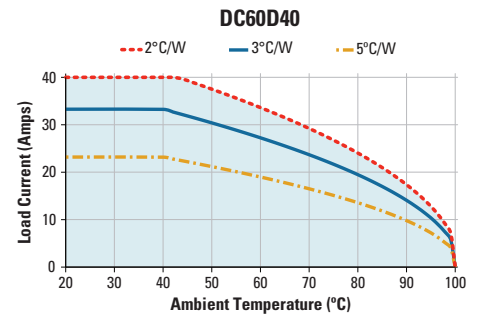
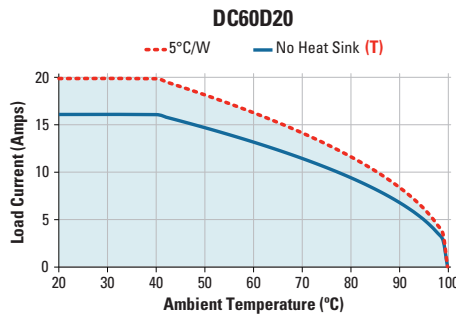
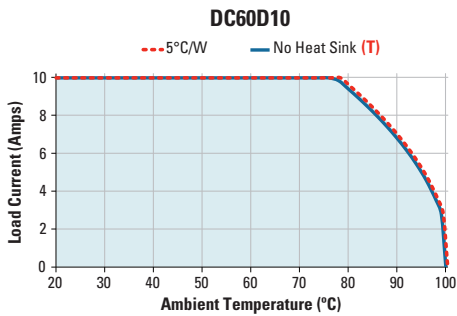

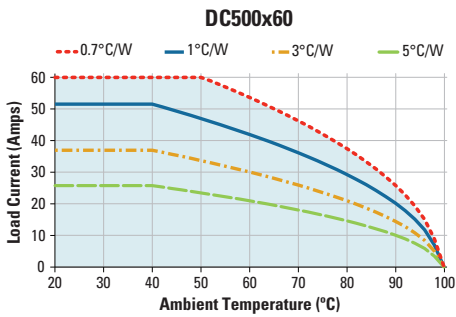
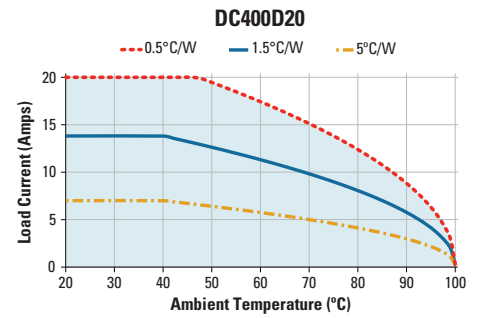
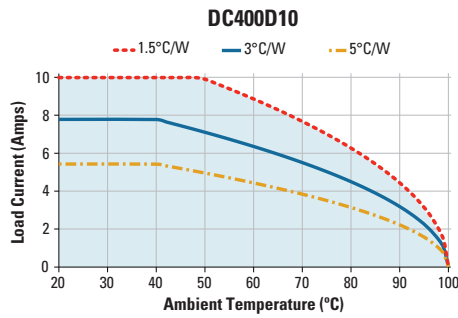
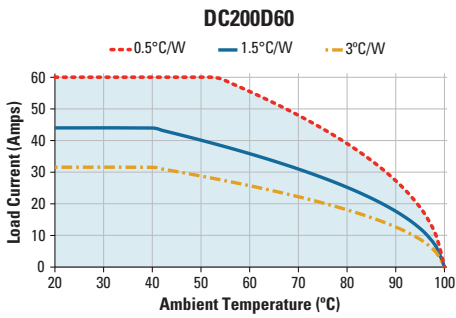
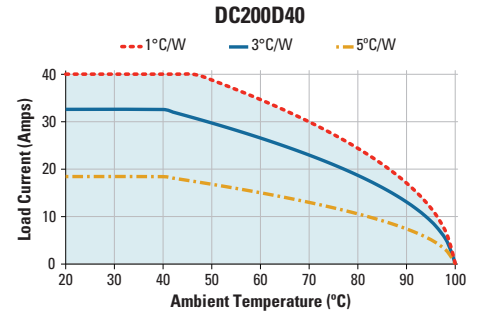
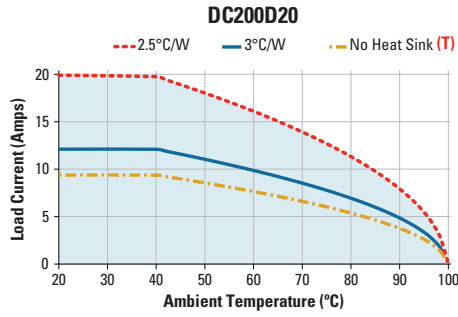
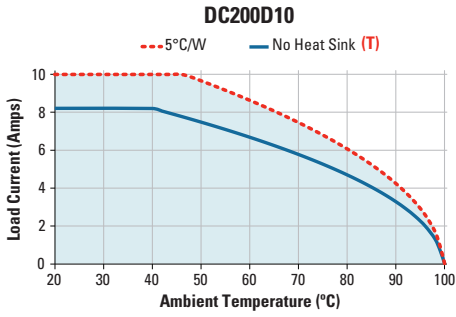

TABLE 3: Heat Sinks

Crydom Part No.	Thermal Resistance [°C/W]
HS501DR	5
HS301 / HS301DR	3
HS251	2.5
HS202 / HS202DR	2
HS201 / HS201DR	2
HS151 / HS151DR	1.5
HS103 / HS103DR	1
HS101	1
HS073	0.7
HS072	0.7
HS053	0.5

General Notes

(T) SSR metal base plate acting as heat sink, it must be exposed to free ambient air.

Surge Current Graphics

Surge Current Duty Factor

--- Single Pulse (*) — Duty Factor (10%) (**)
 - - - Duty Factor (20%) (**)
 — Duty Factor (50%) (**)

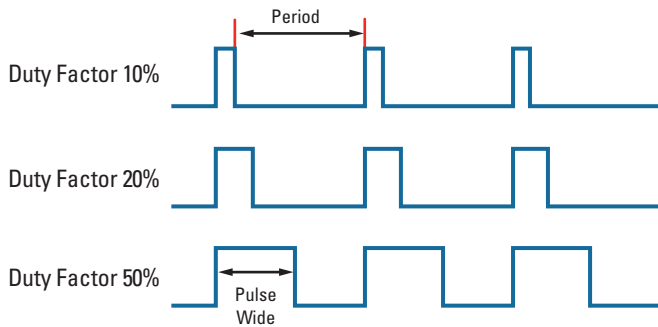
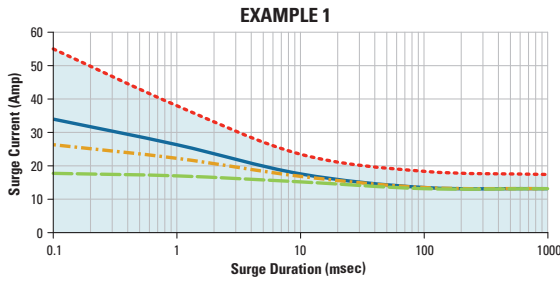

For Pulse Wide Modulation applications select the curve according to duty factor and pulse duration as following.

$$\text{Duty Factor} = \frac{\text{Pulse Wide}}{\text{Period}} \times 100 (\%)$$

(*) for Single Surge Pulse $T_c=25^\circ\text{C}$; $T_j 175^\circ\text{C}$

(**) for Repetitive Surge Pulse $T_c=25^\circ\text{C}$; $T_j 130^\circ\text{C}$

Surge Current Single Pulse

--- Single Pulse (*)

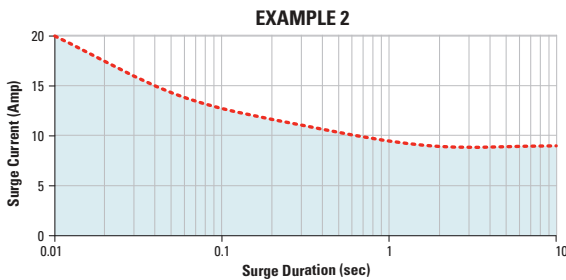

(*) for Single Surge Pulse $T_c=25^\circ\text{C}$; $T_j 150^\circ\text{C}$.

For Single Surge Pulse, AC Output [CW & CL series]: $T_c=25^\circ\text{C}$; $T_j=125^\circ\text{C}$

For AC Output SSRs, AC Rms value of surge current equals the peak value divided by $\sqrt{2}$ (1.414).

Surge Current Graphics: CW Series

CWxx10

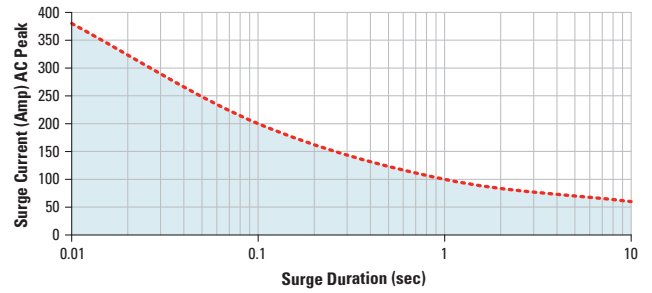

CWxx25

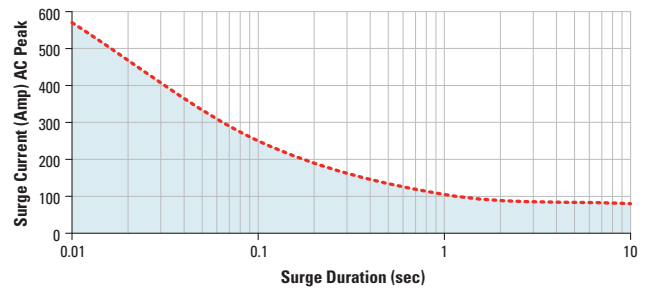

CWxx50

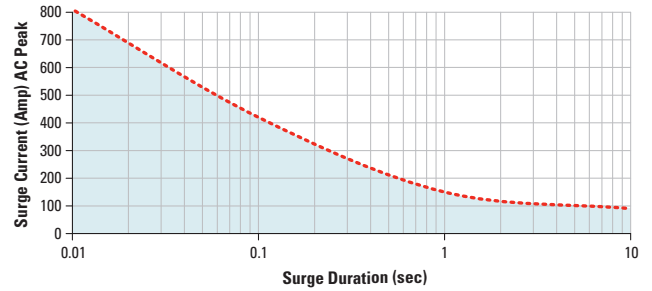

CWxx90

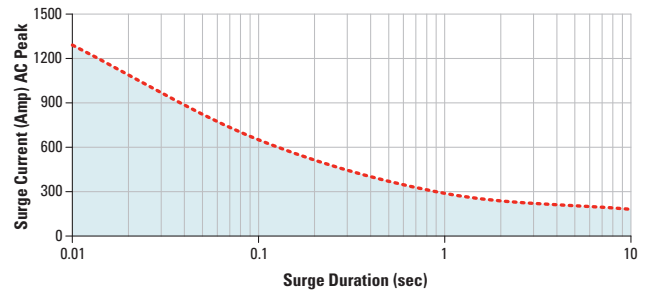

CWxx125

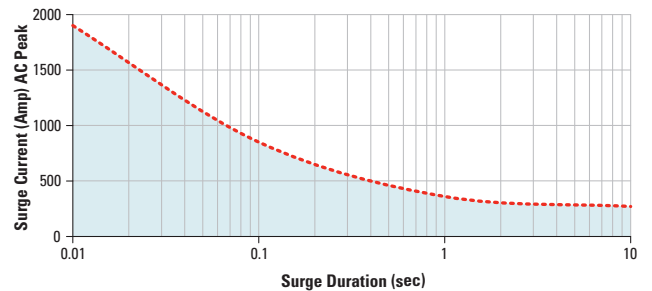

Surge Current Graphics: CL Series

CL240x05

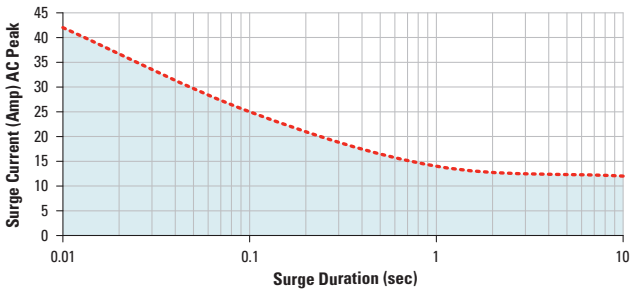

CL240x10

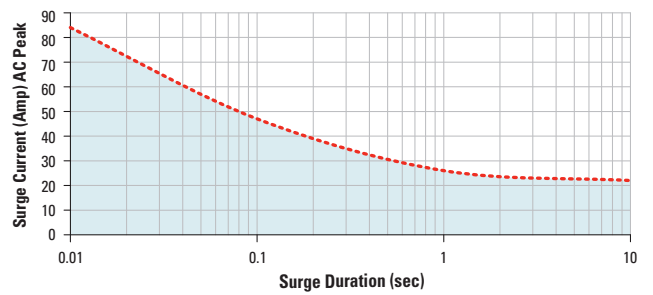

Surge Current Graphics: DC60 Series

DC60Sx3

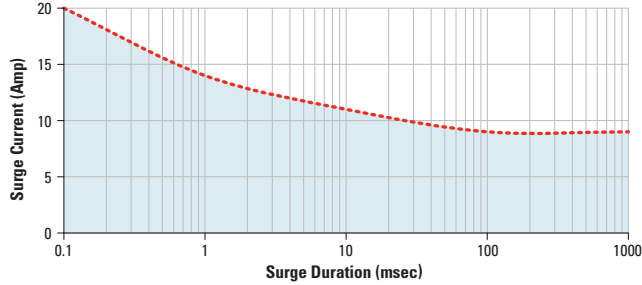

DC60Sx5

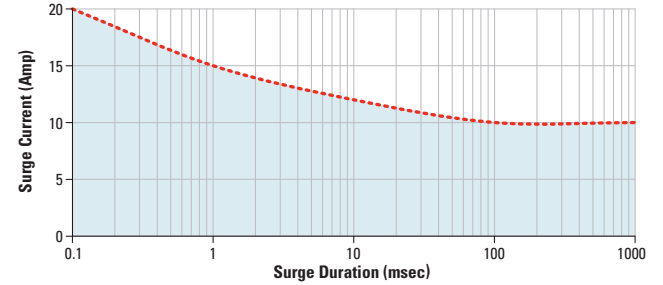

DC60Sx7

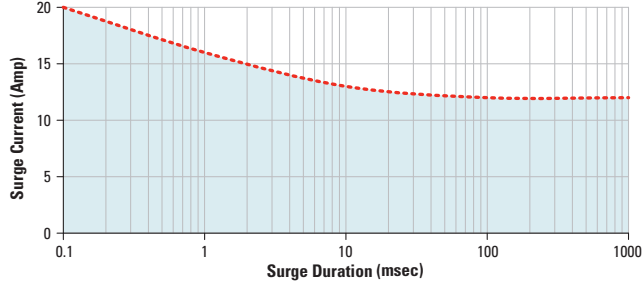

Surge Current Graphics: DC06D Series

DC06D60

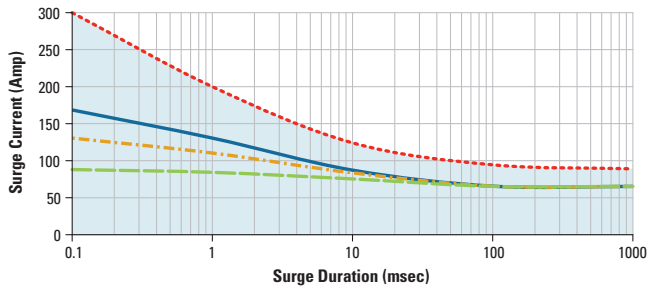

DC06D80

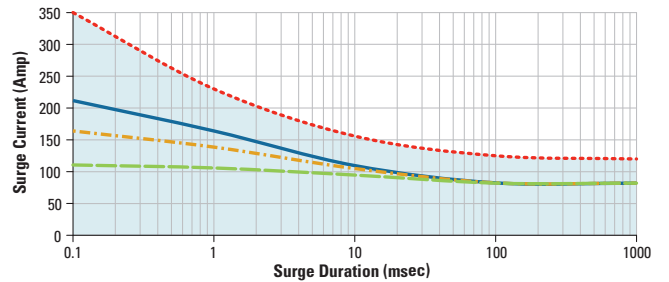

DC06D100

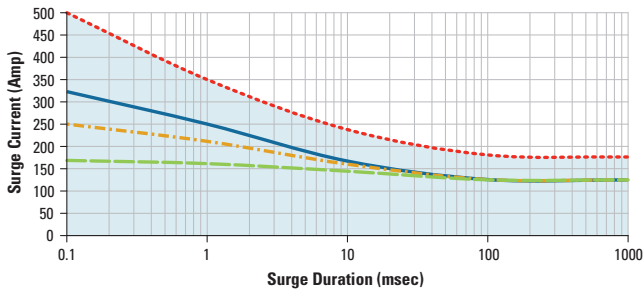

Derating Curves: Series 1-DC & 1-DCL

D1D07

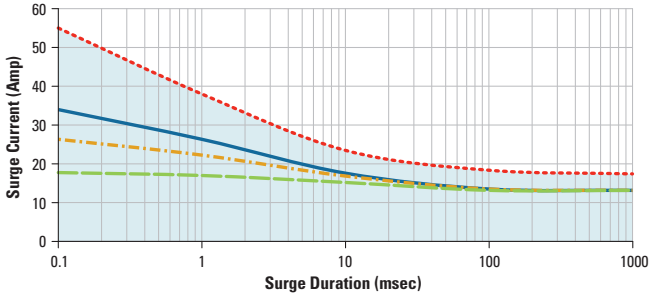

D1D12

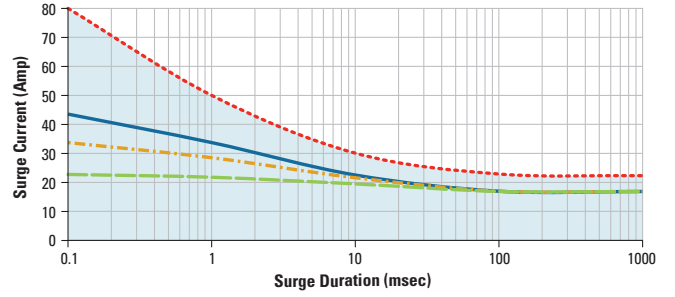

D1D20

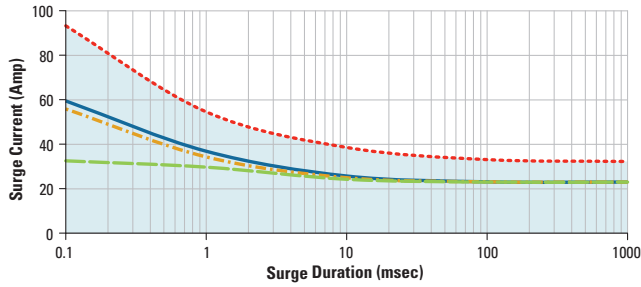

D1D40

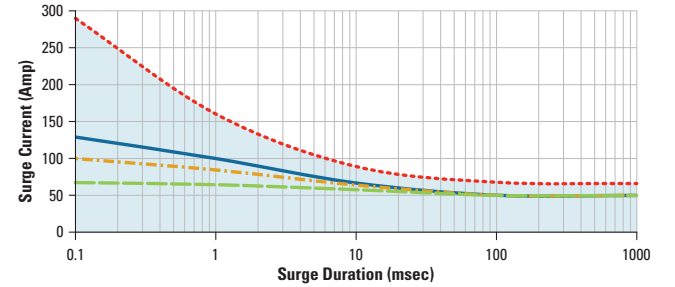

D1D60

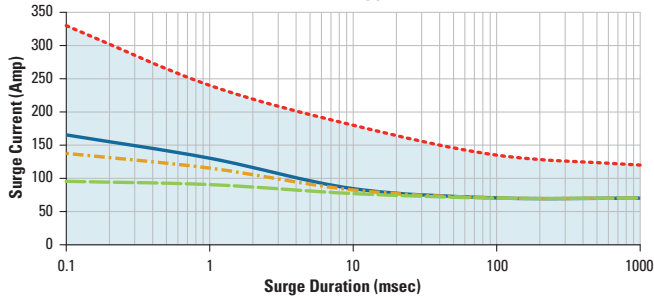

D1D80

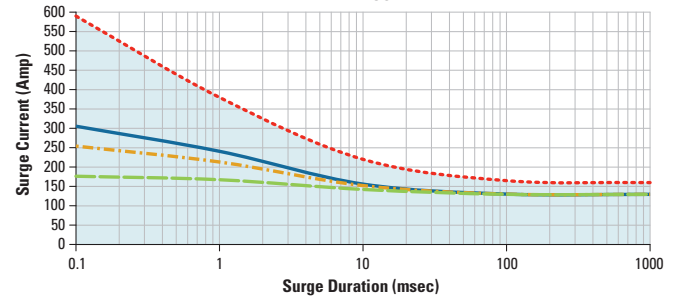

D1D100

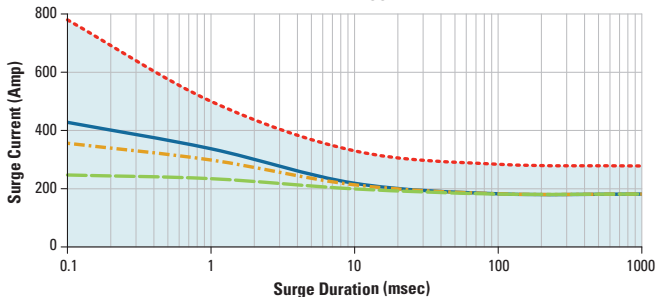

D2D07

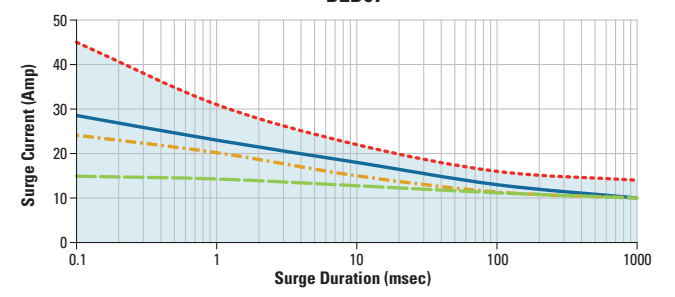

D2D12

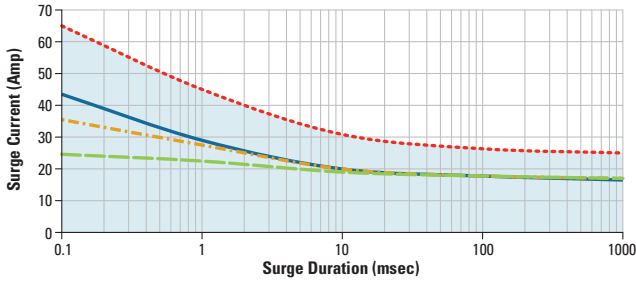

D2D40

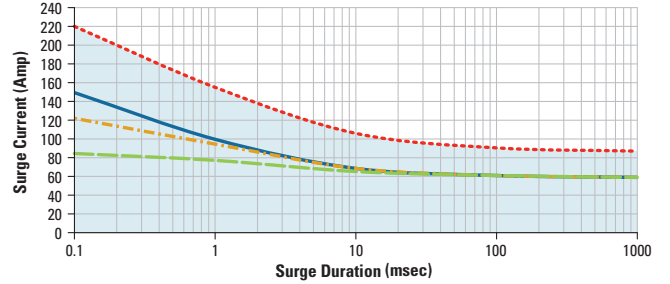

D4D07

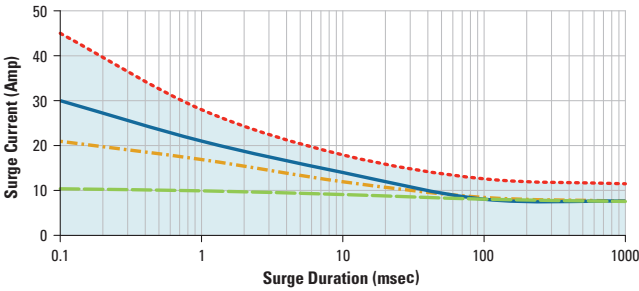

D4D12

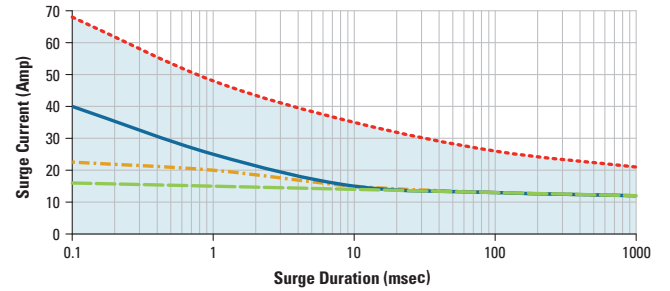

D5D07

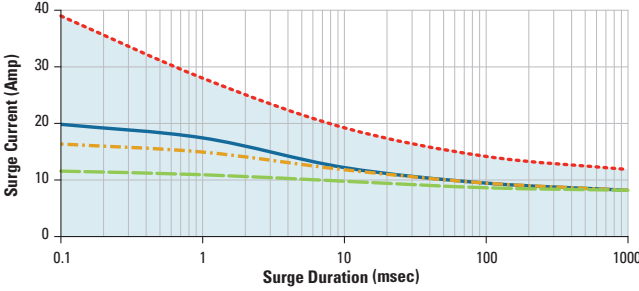

D5D10

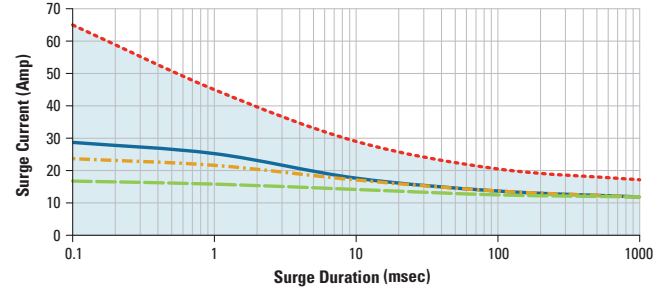

Derating Curves: SSC Series

SSC1000

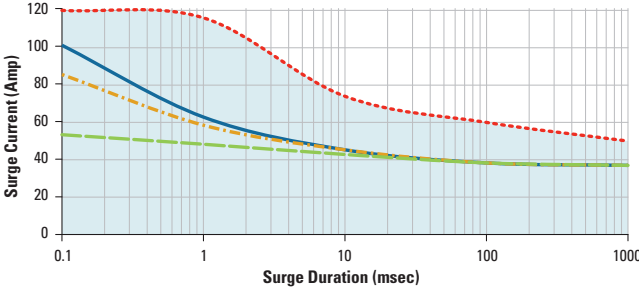

Derating Curves: PowerPlus DC Series

DC60D10

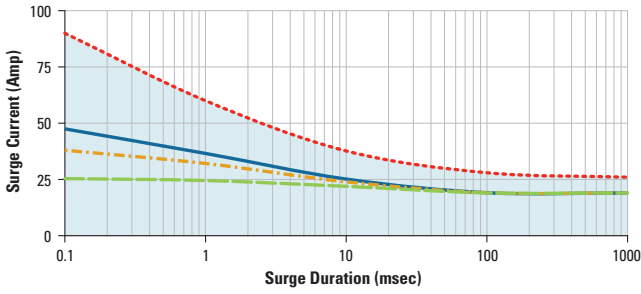

DC60D20

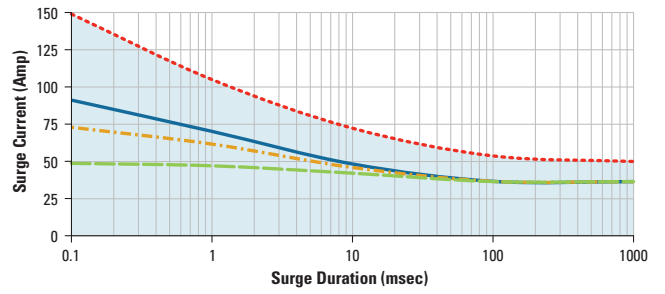

DC60D40

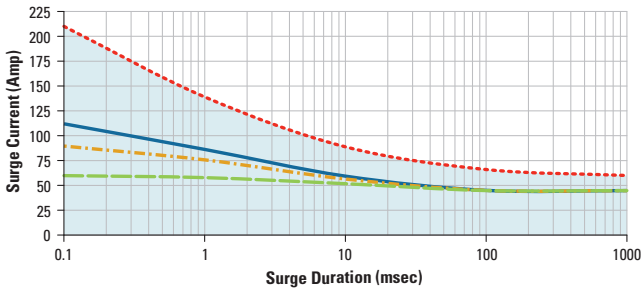

DC60D60

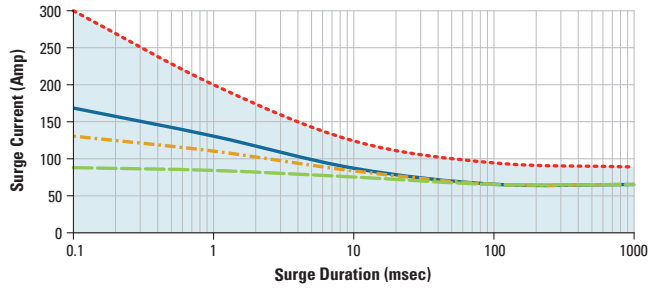

DC60D80

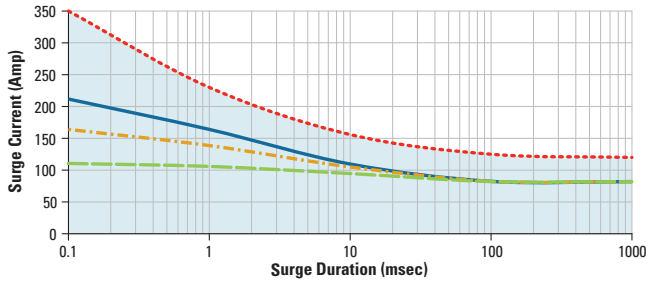

DC60D100

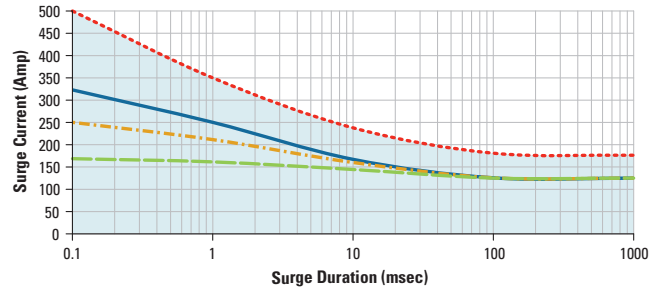

DC100D10

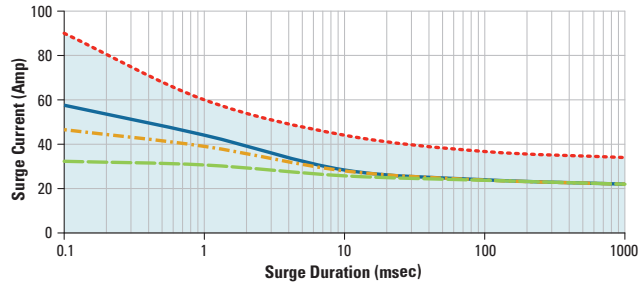

DC100D20

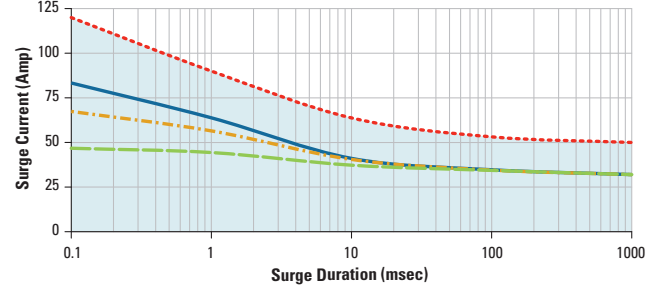

DC100D40

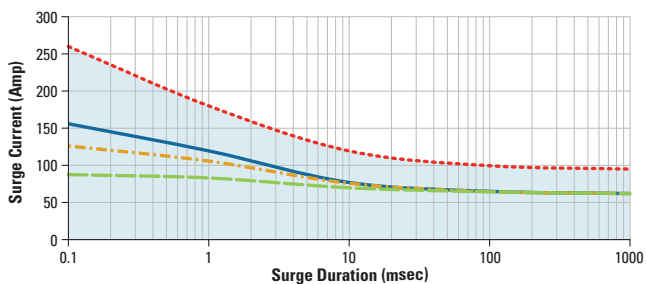

DC100D60

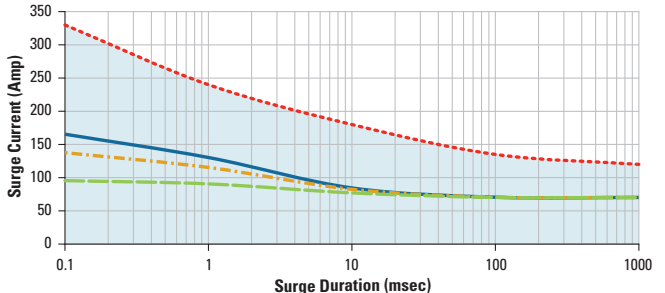

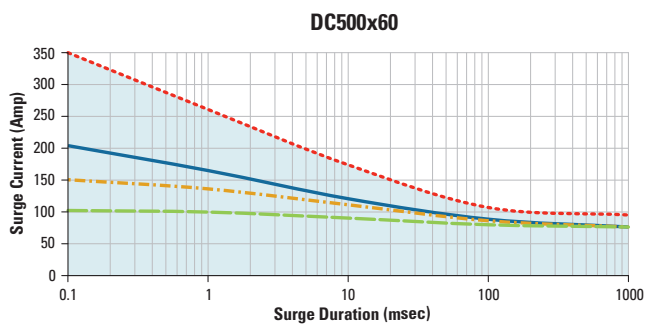
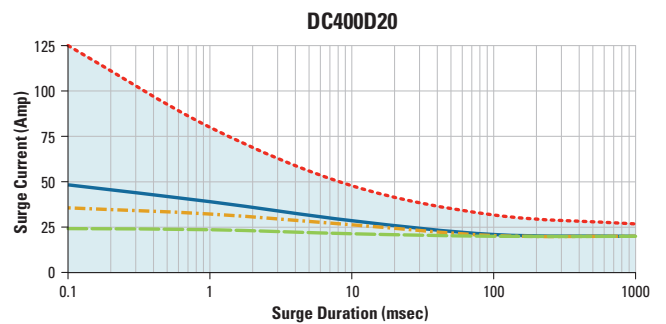
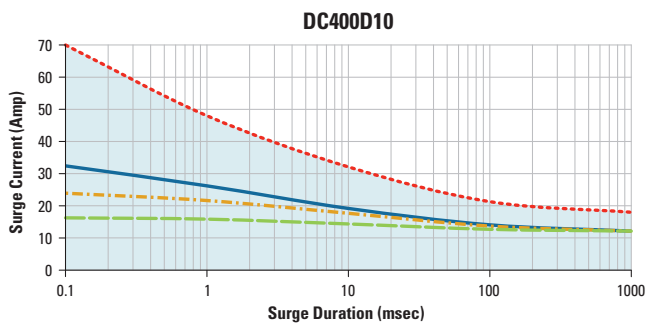
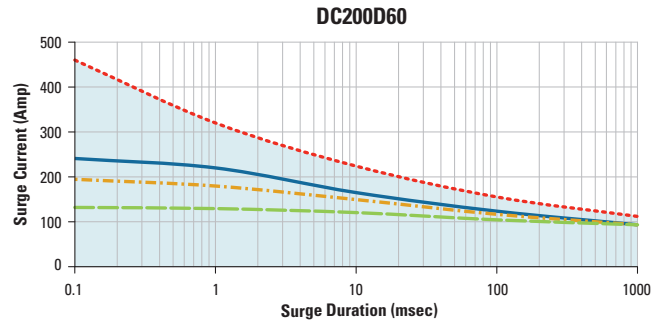
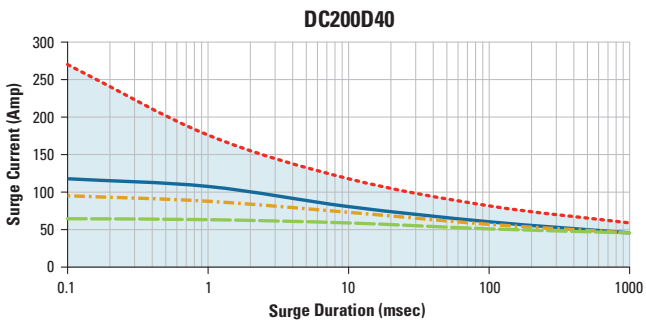
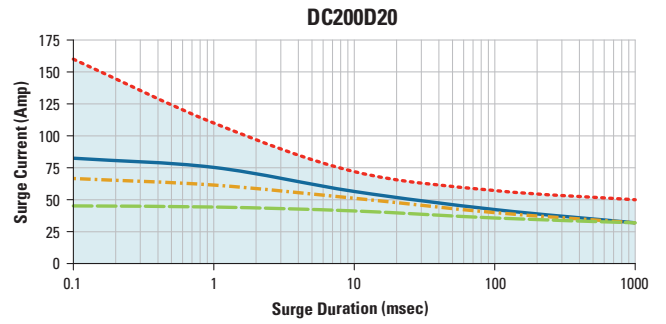
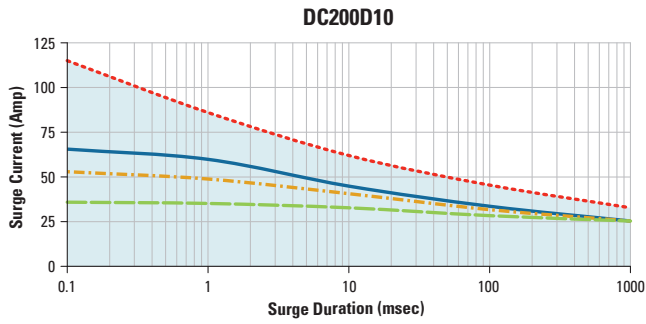
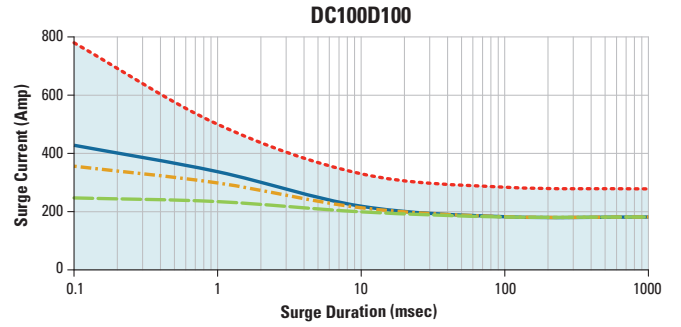
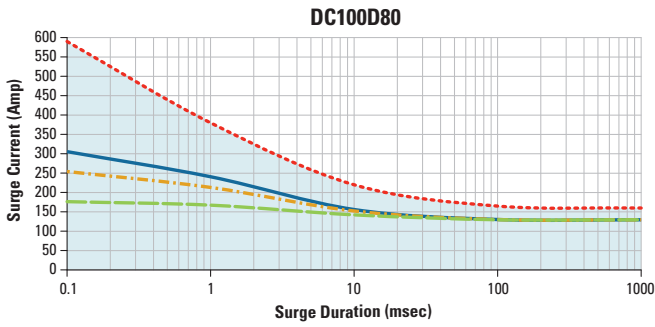

Questions?
Call or e-mail:

America Tel.: +1 (877) 502 5500
e-mail: sales@crydom.com

EMEA Tel.: +44 (0) 1202 606030
e-mail: sales-europe@crydom.com

Asia Tel.: +86 (0) 21 6065 7725
e-mail: sales-cn@crydom.com

crydom®

AMERICAS



United States & Canada

Crydom Inc
2320 Paseo de las Americas,
Suite 201
San Diego, CA 92154

Sales Support:
Tel +1 (877) 502 5500
Fax +1 (619) 210 1590
sales@crydom.com

Technical Support:
Tel +1 (877) 702 7700
support@crydom.com

Mexico

**Automatismo Crouzet
S.A. de C.V.**
Calzada Zavaleta 2505 C Col
Sta Cruz Buenavista C P
72150 Puebla

Sales Support:
Tel +52 (222) 409 7000
Fax +52 (222) 409 7810
sales_mx@crydom.com

Southern & Central American Countries CST Latinoamerica

Alameda Rio Negro, 1030,
18º andar Conjunto 1803
CEP 06454 000
Barueri São Paulo
Brasil
Tel +55 (11) 2505 7500
Fax +55 (11) 2505 7507

EUROPE, MIDDLE EAST & AFRICA



United Kingdom

Crydom SSR Ltd
Arena Business Centre
Holyrood, Close
Poole, Dorset BH17 7FJ

Sales Support
Tel +44 (0) 1202 606030
Fax +44 (0) 1202 606035
sales_europe@crydom.com

Technical Support
support_europe@crydom.com

Austria & Switzerland

Tel +44 (0) 1202 606030
Fax +44 (0) 1202 606035
vertrieb@crydom.com

Belgium

Tel +32 (0) 2 460 4413
Fax +32 (0) 2 461 2614
sales_europe@crydom.com

France

Tel +33 (0) 810 123 963
Fax +33 (0) 810 057 605
sales_europe@crydom.com

Germany

Tel +49 (0) 180 3000 506
Fax +49 (0) 180 3205 227
vertrieb@crydom.com

Italy

Tel +39 (0) 2 665 99 260
Fax +39 (0) 2 665 99 268
sales_europe@crydom.com

Spain

Tel +34 902 876 217
Fax +34 902 876 219
sales_europe@crydom.com

Netherlands

Tel +31 (0) 71 582 0068
Fax +31 (0) 71 542 1648
sales_europe@crydom.com

Middle East, Africa & Other European Countries

Tel +44 (0) 1202 606030
Fax +44 (0) 1202 606035
sales_europe@crydom.com

ASIA



China

**Custom Sensors &
Technologies Asia
(Shanghai) Ltd.**
11th floor
Chang Feng International
Tower
89 Yunling Road (East)
Putuo District
Shanghai, 200062

Sales Support
Tel +86 (0) 21 6065 7725
Fax +86 (0) 21 6065 7749
sales_cn@crydom.com

Technical Support
support_cn@crydom.com

South Korea

**Custom Sensors &
Technologies**
14F, Kbiz DMC Tower,
189, Seongam ro, Mapo gu,
Seoul 121 904, South Korea
Tel +82 2 2629 8312
Fax +82 2 2630 9800
korea@cstsensors.com

India

CST Sensors India Pvt Ltd
4th Floor, Trident Towers,
No 23, 100 Ft Ashoka Pillar Road,
2nd Block, Jayanagar,
Bangalore 560011
Tel +91 (80) 4113 2204 /05
Fax +91 (80) 4113 2206
india@cstsensors.com

East Asia Pacific Custom Sensors & Technologies

2F, No 39, Ji Hu Road
Nei Hu Dist
Taipei 114, Taiwan
Tel +886 2 8751 6388 ext 131
Fax +886 2 2657 8725
eap@cstsensors.com
taiwan@cstsensors.com

